

**DEBIT AND CREDIT CARD
SCHEMES IN AUSTRALIA
A STUDY OF INTERCHANGE FEES
AND ACCESS**

OCTOBER 2000



**RESERVE BANK OF
AUSTRALIA**



**AUSTRALIAN COMPETITION AND
CONSUMER COMMISSION**

The contents of this publication shall not be reproduced, sold or distributed without the prior consent of the Reserve Bank of Australia or Australian Competition and Consumer Commission.

*This publication was designed and typeset by
Publishing Section, Information Department
Reserve Bank of Australia
Printed by Beaver Press Pty Ltd*

ISBN 0 642 70497 X

CONTENTS

EXECUTIVE SUMMARY i

1. ORIGINS AND OBJECTIVES OF THE STUDY 1

2. THE RETAIL PAYMENTS SYSTEM IN AUSTRALIA 7

3. PAYMENT NETWORKS AND INTERCHANGE FEES 23

4. ATM NETWORKS 33

5. CREDIT CARD NETWORKS 43

6. DEBIT CARD NETWORKS 61

7. FINDINGS AND CONCLUSIONS 73

REFERENCES 81



EXECUTIVE SUMMARY

Introduction

- 1. The Payments System Board of the Reserve Bank of Australia and the Australian Competition and Consumer Commission have undertaken a study into one aspect of the Australian payments system - the networks for automated teller machines (ATMs), credit cards and debit cards. The study concentrates on two aspects of these card networks, namely, interchange fees and the conditions of entry into the industry.*
- 2. The study is concerned with the economic efficiency of these networks. Most importantly, are they delivering the best possible service at the lowest cost to end-users? When goods and services are purchased, a payment instrument must be used; this could be a traditional instrument such as cash or a cheque, or one of the newer electronic instruments such as debit and credit cards, or direct debits or credits. Whichever payment instrument is chosen, its cost must be covered either directly by the user through fees and charges or, if not, indirectly because the cost is embedded in the prices of goods and services. To a merchant, selling prices must be high enough to cover all costs, including the cost of the payments mechanism, and leave sufficient profit to keep it in business. It follows that an expensive payments instrument will, at the margin, mean higher prices for goods and services and a more cost-effective one will mean lower prices. The incentives in an economy should ensure that the lowest cost and most efficient payment instruments thrive at the expense of the more expensive or less efficient ones.*
- 3. The incentives in question are largely the fees and charges which consumers face when choosing a payment instrument. Some fees and charges are very transparent and it is relatively easy to make choices based on them. Others are not transparent, but may be just as important in influencing which payment instrument is used and what the resulting cost to the economy is. Interchange fees are an example of the latter. Interchange fees are 'wholesale' fees, which are paid between financial institutions when customers of one institution are provided with card services by another financial institution. Customers do not see these fees directly but the fees affect the incentives they face.*
- 4. In Australia, interchange fees are unique to card networks; they do not apply when customers make payments by cheque, direct credit or direct debit. In those cases, financial institutions seek to recover their costs directly from their own customers.*



5. *The rationale for interchange fees is that they encourage the growth of payment networks by redistributing revenues between participants to induce them to join. In this way, the benefits of the payments network can be maximised. Australia's card networks have grown strongly under the current interchange fee regimes and Australia now possesses world-class ATM, credit card and debit card payment networks which have widespread public acceptance and international compatibility. Even though the networks have reached a high level of maturity, pricing in these networks is still based on interchange fees, which are set by financial institutions at one remove from the cardholders and merchants that ultimately bear these fees. Hence, in contrast to most other markets, end-users of card services do not have any direct influence on the price-setting process. This reduction in the normal market discipline has potential implications for efficiency and equity which need to be weighed against potential network benefits.*
6. *Interchange fees are a technically complex subject. As background to its analysis, the study collected data on interchange fees from all participants in ATM, credit card and debit card payment networks, as well as from the three credit card schemes in Australia which have interchange fees (MasterCard, Visa and Bankcard). It collected detailed costs and revenue data from a smaller group of nine financial institutions, which are involved in over 95 per cent of debit and credit card transactions in Australia.*

ATM networks

7. *In ATM networks, interchange fees are negotiated bilaterally and are paid by the card issuer to the ATM owner. They are designed to reimburse the ATM owner for costs incurred in providing ATM services to the issuer's customers. Interchange fees for cash withdrawals average around \$1.03 per transaction and have changed little over the past decade. The cost of providing ATM cash withdrawals averages \$0.49 per transaction.*
8. *ATM interchange fees are normally passed on by card issuers to their cardholders whenever they use another institution's ATM, through foreign ATM fees. These fees average around \$1.35 per transaction. As a consequence, cardholders using another institution's ATM are paying considerably more than the cost of providing the service. Because of the revenue flow to the industry from such cardholders, financial institutions have no clear incentives to negotiate lower interchange fees.*
9. *An alternative to interchange fees in ATM networks would be a direct charging regime in which ATM owners could seek to recover their costs directly from cardholders of other institutions using their ATMs.*



Credit card networks

10. *In credit card networks, interchange fees are agreed jointly by financial institutions which are members of the card schemes, and are paid to the card issuer by the merchant's financial institution. These fees are seen as a means by which the merchant contributes to the issuer's costs. Separate interchange fees, calculated as a percentage of the value of the transaction, normally apply for electronic transactions and other transactions. The average interchange fee per transaction is 0.95 per cent.*
11. *Credit card interchange fees have not been regularly reviewed by the financial institutions which are card scheme members using any formal methodology. Cost-based methodologies for calculating interchange fees would suggest interchange fees much lower than the current levels.*
12. *Credit card issuers earn about one-third of their revenues from interchange fees and around one-half from the interest margin on credit card lending. For an average credit card transaction of \$100, total revenues from credit card issuing average \$2.69 per transaction compared with costs of \$1.93 per transaction - a mark-up over costs of 39 per cent. Credit card acquirers incur costs of \$0.43 per transaction and have revenues, after paying interchange fees to issuers, of \$0.72 per transaction - a mark-up over costs of around 67 per cent.*
13. *In credit card transactions over the telephone or Internet, merchants are unable to verify signatures and card issuers usually do not guarantee payments to merchants for such transactions. In many countries, a lower interchange fee is charged for these 'card not present' transactions to reflect the absence of a guarantee. In contrast, such transactions in Australia attract the highest interchange fee. The study can see no logical basis for this practice.*
14. *Credit card acquirers pass interchange fees, and their own acquiring costs, onto merchants through merchant service fees. These fees average 1.78 per cent of the value of a credit card transaction. 'No surcharge' rules in the international credit card schemes (MasterCard and Visa) prevent merchants, in turn, passing these fees onto credit cardholders. Credit card costs are therefore built into the prices of goods and services and are recovered from all customers, whether or not they use credit cards. As a consequence, credit cardholders and financial institutions which are credit card scheme members are subsidised by other consumers. The study's view is that 'no surcharge' rules suppress important signals to end-users about the costs of the credit card network, and that such rules are not desirable.*



-
15. *In the international credit card schemes, participation is explicitly restricted to authorised deposit-taking institutions. The study believes that these restrictions, as they apply to credit card acquiring, cannot be justified. Their application to card issuing may also be overly limiting and needs to be reviewed. The study is particularly concerned about the lack of transparency and objectivity in the membership procedures for Bankcard.*

Debit card payment networks

16. *In debit card payment networks, interchange fees are negotiated bilaterally and are paid by the card issuer to the merchant's financial institution (the acquirer). These fees have been justified as a means by which the acquirer can recoup the costs of the debit card infrastructure from cardholders. Acquirers earn revenues from interchange fees of around \$0.20 per transaction, and revenues from merchant service fees of around \$0.12 per transaction. They incur costs of around \$0.26 per transaction, giving a mark-up of revenues over costs of 23 per cent. This mark-up is much lower than in credit card acquiring although infrastructure and procedures are very similar. The major reason is that large merchants have invested in their own acquiring infrastructure and have negotiated arrangements to share interchange fees with their financial institution.*
17. *The payment of a debit card interchange fee to acquirers is an arrangement unique to Australia. In other countries, the payment is to the card issuer or there are no interchange fees at all. The study did not find a convincing case for an interchange fee in the debit card payment network in Australia, in either direction.*

Competition and price incentives

18. *Competitive pressures in card payment networks in Australia have not been sufficiently strong to bring interchange fees into line with costs. The end-users of these services - cardholders and merchants - have no direct influence over the setting of interchange fees but must rely on their financial institutions to represent their interests. Large financial institutions have the dominant influence on interchange fee setting; however, since they are both issuers and acquirers and benefit from the revenue generated, they have little incentive to press for lower interchange fees. Where financial institutions can readily pass interchange fees onto their customers, as they can for ATM and credit card transactions, there is even less pressure for interchange fees to be lowered. As a consequence, the price signals and competitive responses that would be expected to put pressure on margins in card payment networks have not worked effectively. These difficulties are reinforced by restrictions on entry to the card networks, both*



explicit and informal, and by the ‘no surcharge’ rules in credit card schemes. In the debit card payment network, however, large merchants with their own acquiring infrastructure have provided a countervailing force to traditional acquirers.

- 19. Under current arrangements, cardholders are effectively being paid by card issuers to use a credit card as a payment instrument, but they face a transaction fee for using a debit card (after a number of fee-free transactions). This structure of incentives has encouraged the growth of the credit card network at the expense of other payment instruments, particularly debit cards and direct debits, that consume fewer resources. As a result, Australia has a higher cost retail payments system than necessary, and much of this higher cost is borne by consumers who do not use credit cards.*
- 20. The study has concluded that the interests of end-users of card payment services need to be more directly engaged in the pricing process and conditions of entry to card payment networks need to be more open than at present.*



1. ORIGINS AND OBJECTIVES OF THE STUDY

1.1 INTRODUCTION

Debit and credit cards are now a significant feature of the retail payments landscape in Australia, after growing strongly in usage over recent years. During 1999, debit and credit cards were used to make 1.2 billion transactions worth \$91 billion. These transactions accounted for around 43 per cent of the number of non-cash payments made in that year, three times their share at the beginning of the decade. In the process, debit and credit cards have replaced a large number of transactions that would otherwise have been made using cash or other payment instruments such as cheques.

Customers who hold debit and credit cards, and merchants that accept the cards for payments, generally pay fees to their financial institution for the card services they receive. Less well known, however, is that the financial institutions involved in card transactions also pay fees to each other. For example, when a cardholder uses an automated teller machine (ATM) owned by a financial institution other than their own, the cardholder's financial institution pays the ATM owner a fee. Similarly, when a consumer makes a purchase using a credit card, the merchant's financial institution, known as the 'acquirer', pays a fee to the issuer of the credit card (if it is another institution). Fees paid by financial institutions to one another are called interchange fees. In Australia, these wholesale fees are unique to card schemes operated by financial institutions – there are no interchange fees when payments are made by cheque or direct entry.

Interchange fees have been an integral part of the pricing structure in card schemes. They have a strong influence on the revenue flows associated with card transactions, the costs ultimately borne by merchants and cardholders, the incentives to use and accept debit and credit cards, and the terms on which financial institutions and other providers of payment services can gain access to some card networks. Interchange fees therefore have important implications for both efficiency and competition in the retail payments system in Australia.

Notwithstanding this, interchange fees are not transparent. In the case of ATMs and debit card schemes, the fees are determined in confidential bilateral agreements between financial institutions, and participants in the schemes do not know the full range of interchange fees. In the case of credit cards, interchange fees are agreed jointly by the financial institutions that are members of each of the card schemes and, within each scheme, the same fee structure applies to all credit card transactions. Participants in the card schemes know the interchange fees but the fees are not more widely known. This lack of transparency has made it difficult to assess the implications of interchange fees.



1.2 PREVIOUS STUDIES ON CARD SCHEMES

Over the past decade, debit and credit card schemes have been the subject of a number of official and other studies in Australia. Interchange fee arrangements, however, were not the main focus of these studies and none had access to detailed cost data from financial institutions on which rigorous analysis could be based.

PRICES SURVEILLANCE AUTHORITY

Regulatory authorities in Australia first raised questions about interchange fees in a 1992 report on credit card interest rates by the Prices Surveillance Authority (PSA).¹ In a wide-ranging inquiry that looked at, amongst other things, the profitability of credit card operations, the PSA noted that interchange fees for credit cards had not changed despite technological improvements and the increasing scale of credit card operations. It also questioned why fees to merchants were charged on an ad valorem rather than flat rate, since the costs incurred by their financial institutions varied more directly with the number of transactions than their value.² The PSA advised that it had been unable to examine interchange fees fully and recommended that the efficiency and structure of these fees be subject to further review.

Interchange fees were again raised by the PSA in its 1995 report on fees and charges on retail transaction accounts.³ The PSA noted that, despite a number of indications that unit costs for debit card transactions should have fallen over the 1990s, interchange fees in debit card payment schemes had not changed since they were first negotiated in the late 1980s. The report concluded that it was unlikely that interchange fees were efficiently priced and expressed concern that inequalities in bargaining power between participants in debit card schemes were resulting in market distortions. The report recommended that a review of debit card interchange fees be undertaken.

AUSTRALIAN PAYMENTS SYSTEM COUNCIL

In its 1995/96 Annual Report, the Australian Payments System Council examined the mechanics of card schemes and the rationale commonly put forward for their pricing structures.⁴ The Report identified the interchange fees applying in debit and credit card schemes and noted that debate had arisen among banks and merchants about these fees. For example, some merchants had questioned why credit card interchange

1. Prices Surveillance Authority (1992).
2. An ad valorem fee is one calculated as a percentage of the value of the transaction; a flat fee is a fixed amount, irrespective of the value of the transaction.
3. Prices Surveillance Authority (1995b).
4. Australian Payments System Council (1996). The Australian Payments System Council was a non-statutory body, chaired by the Reserve Bank, which advised the Treasurer on developments in the payments system and sought, amongst other things, to foster improvements to the payments system. The Council operated between 1984 and 1998.



fees had not fallen in response to reductions in credit card fraud from the introduction of on-line connections, or to the charging of annual fees to cardholders. However, the Council made no attempt to pass judgment about pricing practices.

FINANCIAL SYSTEM INQUIRY

As part of its review of the Australian financial system, the Financial System Inquiry (the Wallis Committee) established by the Government in 1996 devoted attention to the efficiency and governance of the payments system.⁵ The Inquiry strongly advocated the substitution of electronic forms of payment for paper-based transactions as a means of achieving substantial gains in efficiency. Though debit and credit card schemes were already largely electronic, the Inquiry nonetheless thought that the industry arrangements then current had the potential to affect payments system efficiency adversely. In particular, it noted that:

- the use of ad valorem interchange fees for credit cards meant that the cost of providing this payment mechanism to consumers could be very high. This cost was not transparent but was ultimately borne by consumers in the form of higher prices;
- concerns had been raised about the size of interchange fees on credit cards and whether the pricing of debit card interchange fees was appropriate; and
- the relative bargaining power of major card acquirers and issuers over interchange fees was uneven and regional banks had found it difficult to gain access to the debit card network as acquirers.

The Inquiry itself lacked access to sufficient data in this area to reach any conclusions. Instead, it recommended that interchange fee arrangements be reviewed by a new Payments System Board within the Reserve Bank and by the Australian Competition and Consumer Commission (ACCC). The Inquiry also noted that the rules of the international credit card associations (MasterCard and Visa) were not transparent and may limit membership to the existing range of financial institutions. Accordingly, it recommended that the ACCC maintain a watching brief over credit card rules and membership arrangements.

1.3 OBJECTIVES OF THE STUDY

In Australia's new financial regulatory structure, introduced in mid 1998 in response to the Financial System Inquiry, two bodies have regulatory responsibilities for competition and access in the payments system. The Payments System Board of the Reserve Bank has an explicit mandate to promote competition and efficiency, consistent with the overall stability of the financial system. The ACCC has a long-standing

5. *Financial System Inquiry Final Report* (1997).



involvement in analysis of retail payments arrangements and particular responsibility for dealing with co-operative arrangements which might contravene the *Trade Practices Act 1974*. The respective responsibilities are co-ordinated through a Memorandum of Understanding between the Reserve Bank and the ACCC, which was published in September 1998.⁶

In September 1999, the Payments System Board and the ACCC announced a joint study into interchange fees for debit and credit cards, and membership criteria for credit card schemes. The objectives of the study were to:

- obtain information on interchange fees paid by financial institutions;
- clarify the basis on which interchange fees are set, looking particularly at the role of costs;
- assess whether current interchange fees are encouraging efficient provision of debit and credit card services; and
- obtain information on current restrictions on credit card scheme membership.

While the recommendations of the Financial System Inquiry on card schemes were a major motivation for the study, other factors were also important. The ACCC was already dealing with interchange fee issues in the context of an application by the Australian Payments Clearing Association (APCA) in 1997 for authorisation of its proposed rules for the Consumer Electronic Clearing System. Noting the earlier findings of the PSA, the ACCC considered that the inequality of bargaining power between participants in ATM and debit card payment networks when negotiating interchange fees would place some participants at a cost and competitive disadvantage in providing payment services, effectively restricting their access to the networks. To overcome this, the ACCC asked APCA to require its members to base their ATM and debit card interchange fees on 'efficient pricing principles', which would result in fees reflecting, as far as possible, directly attributable costs. APCA subsequently advised the ACCC that it did not have the capacity to undertake self-regulation of interchange fee arrangements.⁷

As additional background to the study:

- merchants have expressed concerns to the Reserve Bank and the ACCC that restrictions on membership of credit card schemes place them in a worse bargaining position when negotiating fees than is the case for debit card transactions;
- some financial institutions have suggested that interchange fees for debit card payments are anti-competitive, making it difficult for new and smaller players to enter the business. As explained in this study, interchange fees for debit card

6. Reserve Bank of Australia (1998).

7. In August 2000, the ACCC issued a final determination granting authorisation for a period of three years in respect of (amended) arrangements for the Consumer Electronic Clearing System. The amended arrangements do not include self-regulation of ATM and debit card interchange fees.



payments in Australia run in the opposite direction to those overseas, leading to the claim that the arrangements result in an inefficient sharing of costs; and

- preliminary investigations by the Payments System Board, outlined in its 1999 *Annual Report*, suggested that interchange fee arrangements for credit cards may be encouraging the use of credit cards relative to more efficient payment instruments.

To meet its objectives, the study obtained information on debit and credit card interchange fees from a total of 30 financial institutions and the three credit card schemes in which interchange fees apply (MasterCard, Visa and Bankcard). More detailed data on the costs and revenues associated with providing card services were obtained from a smaller group of nine financial institutions, which together are involved in over 95 per cent of debit and credit card transactions in Australia. Participants were also invited to offer views on the rationale for interchange fees, the current levels of these fees and conditions of access for new participants. Most institutions responded to requests for data in a co-operative spirit. In a small number of cases, however, the Payments System Board found it necessary to use its formal powers under the *Payment Systems (Regulation) Act 1998* to gather information.

Although they have many similarities with credit cards, store cards and charge cards such as American Express and Diners Club are usually not issued by financial institutions and do not have interchange fee arrangements. The operations of these card schemes are outside the scope of this study. Nonetheless, the study is mindful that its findings on credit card schemes may have implications for the competitive position of credit cards vis-à-vis store cards and charge cards.

The study's analysis and findings on interchange fees and access are set out in this report. It highlights, in particular, the issues that the Payments System Board and the ACCC consider relevant for judging whether current arrangements are conducive to competition and efficiency in the payments system. The study's focus is on wholesale pricing structures in credit and debit card schemes. At the same time, interchange fees are important determinants of the charges facing merchants and cardholders, and these relationships are explored in the report. Retail fees and charges as such, however, are not the focus of this study.

The report is organised as follows. Chapter 2 provides some background information on the retail payments system in Australia and on the operations of ATM, credit card and debit card networks. Chapter 3 outlines the economic rationale for interchange fees and how they might be determined in practice. Chapters 4, 5 and 6 discuss, in turn, the three card networks; though these networks have some common features, the interchange fee arrangements and the associated costs and revenue flows are quite different. The final chapter draws together the main findings and conclusions of the study.



During the course of the study, a separate investigation of interchange fees in credit card schemes was conducted by the Enforcement Division of the ACCC. Following that investigation, the ACCC wrote to various financial institutions and to the three credit card schemes in Australia informing them that, in its view, the joint setting of credit card interchange fees is a likely breach of Section 45 of the *Trade Practices Act 1974*. The ACCC has now instituted proceedings under that Act against one major bank. The study has had no involvement with this investigation and the subsequent legal proceedings; information on credit card costs and revenues provided to the study by individual financial institutions has at all times been kept confidential to the Reserve Bank.



2. THE RETAIL PAYMENTS SYSTEM IN AUSTRALIA

2.1 PAYMENT INSTRUMENTS

The payments system is a generic term for the arrangements under which funds flow between individuals, financial institutions, businesses and the government sector. The retail payments system encompasses the myriad of small-value payments which take place between individuals and between individuals and merchants, as well as the larger payments that take place between businesses. The main instruments used for retail payments in Australia are cash; paper-based instruments such as cheques; electronic instruments such as direct debits and credits; and card-based instruments such as debit and credit cards.⁸

Cash is used to transfer value between participants without the involvement of financial institutions. Although turnover data are not available, cash probably remains the most important retail payment instrument in Australia, particularly for small transactions. Indirect evidence of this is the continued strong growth in the value of cash withdrawals from ATMs – until recently, annual withdrawals from ATMs exceeded the value of payments made by debit and credit cards combined.

Nonetheless, non-cash payment instruments have become increasingly popular over recent years. These instruments transfer value between the payer and the recipient (or ‘payee’) across the books of financial institutions. In many cases, such as debit cards and direct debits, the instruments allow the payer to draw on a transaction account, traditionally provided by banks, building societies and credit unions in Australia. These institutions offer their customers a variety of methods for making payments. The current usage of non-cash retail payment instruments in Australia is shown in Table 2.1.

**Table 2.1: Number of non-cash retail payments
per cent, May 2000**

Cheques	27
Credit cards	24
Debit cards	21
Direct entry credits	20
Direct entry debits	8
	<hr/>
	100

Source: Australian Payments Clearing Association

8. This chapter draws on a number of publications including Bank for International Settlements (1999) and Bullock and Ellis (1998).



Cheques have been, for many years, the means by which most Australians made non-cash payments. Cheques are most often used where the payer has an ongoing relationship with the recipient, such as in bill payments.⁹ Though still the most frequently used non-cash instrument, cheques have been losing ground to debit and credit cards; their share of non-cash payments has declined from 50 to 27 per cent over the six years to 2000.

Direct entry credits and debits are automated payment instruments. Direct credits are mainly used by government agencies and companies for bulk payments of salaries, pensions, interest and dividends and social security benefits. In contrast to many European countries, direct credits are little used for payments between individuals. With direct debits, the payer provides a standing authorisation for payments to a particular recipient, such as a utility or health fund; the recipient can then, through its financial institution, initiate payment at its discretion. Direct debits are a low cost means of paying recurring bills but are yet to win widespread customer acceptance in Australia.

Debit and credit cards are a convenient means of payment at the point-of-sale. In each case, the merchant is guaranteed payment by its financial institution provided established procedures are followed. From the cardholder's perspective, however, the two instruments are different.

A debit card is a method of accessing a transaction account, and the cardholder has funds taken from that account at the time the transaction is made. Such accounts may include an overdraft limit, but this is a separate decision for the financial institution and use of the overdraft is paid for separately by the cardholder. In this sense, a debit card provides a pure payment service. A credit card, on the other hand, provides a payment service and a credit facility; the latter usually involves an interest-free period before the account needs to be settled and a pre-approved line of credit, often called a 'revolving' line of credit, on which users pay a rate of interest. The cardholder pays their credit card account some time after the transaction, according to an established billing cycle.

The use of debit and credit cards for retail payments has been increasing sharply. Since the system was established around ten years ago, the number of debit card payments per capita has risen to 33 a year. Over the same period, the number of credit card transactions per capita has risen from under ten to 34 a year. More details on debit and credit cards are provided in Section 2.4.

9. In Australia, cheques have never been heavily used at the point-of-sale. Countries where this is the case usually have some form of 'cheque guarantee service' under which merchants are guaranteed payment up to a specified limit by a financial institution or another party.



2.2 THE PAYMENT PROCESS

There are normally four parties involved in non-cash payment systems: the payer, their financial institution, the recipient of the funds, and their financial institution. The payment process involves a flow of information and payment instructions between these parties to ensure that funds are transferred from the account of the payer to that of the recipient. (In contrast, ATM networks may involve only three parties because the payer and recipient are the same party.)

The specific message flows and the timing of fund transfers vary by instrument. If a payment is made by cheque, for example, the proceeds are typically credited to the recipient's account and debited from the payer's account on the day the cheque is deposited. Under industry best practice in Australia, cheque funds would be available for use by the recipient in three days if the cheque is cleared electronically; many institutions also have special arrangements with some customers to make funds available more quickly. With a payment by credit card, the recipient usually receives funds at the end of the day or within days of the transaction but the payer may not be required to pay their credit card account until up to 40 to 50 days later. Confirming funds availability may take a number of days for a cheque but on-line authorisation of debit or credit card transactions by the payer's financial institution takes place within seconds.

The roles of the parties in the payment process also vary between instruments but there are some common features:

- the payer needs to authorise the transaction. A signature and/or Personal Identification Number (PIN) provides verification that the individual making the payment has authorised the transaction. Such verification is not possible, however, in so-called 'card not present' transactions, such as payments by telephone or Internet;
- the payer's financial institution verifies that the payer can complete the transaction. In the case of a cash withdrawal from an ATM and a debit card payment at the point-of-sale, this involves verifying that the payer has sufficient funds in their account. In the case of a credit card transaction, it involves verifying that the payer has not exceeded their credit limit. The payer's financial institution also settles the payment with the recipient's financial institution; and
- the payer's and recipient's financial institutions usually process the payment information and ensure that accounts are updated.

Financial institutions perform further specific roles in debit and credit card schemes. Most importantly, the card issuer (ie the payer's financial institution) guarantees payment provided the merchant follows established authorisation procedures. Whether



the issuer takes on a credit risk to its cardholder in providing this guarantee depends on the type of card. For a debit card transaction that is authorised on-line, and can only proceed if the cardholder has adequate funds, no credit risk arises. For a credit card transaction, however, the issuer does not receive reimbursement from the cardholder until some time in the future, and hence assumes credit risk by providing the guarantee.

2.3 PRICING OF PAYMENT SERVICES

Financial institutions incur costs in providing payment services for their customers. These costs arise, for example, from the production and distribution of cards, authorisation and processing of transactions, account maintenance and telecommunications and equipment costs. Costs vary according to the type of payment instrument.

Though payments are not costless, financial institutions have not always charged customers for these services. In such cases, customers have been subsidised by other revenue streams, particularly the margin between interest rates paid on deposits and interest rates received on loans. Over recent years, however, competition has narrowed interest margins and financial institutions have started to charge for many payment services that were previously provided free or at a very low price.¹⁰

Fees and charges to customers are matters for individual financial institutions. Broadly, the types of fees that payers and recipients might expect to pay for different payment services are summarised in Table 2.2. The table also shows whether financial institutions pay interchange fees to each other for these services.

Most institutions charge payers a flat fee per transaction to access their deposit accounts, after a number of fee-free transactions per month. However, there are normally no fee-free transactions if customers use ATMs owned by other institutions. Credit card payments do not incur transaction fees but most card issuers impose annual fees and late payment and other fees.¹¹ Most institutions charge recipients for processing payments. For example, companies depositing cheques are typically charged a fixed processing fee per cheque; similarly, they are usually charged a fee when direct debits are collected. Charges to merchants in debit and credit card schemes are known as merchant service fees. The merchant pays this fee to its financial institution when it accepts credit card transactions. Most merchants also pay merchant service fees to

10. Background on interest margins and bank fees is provided in Reserve Bank of Australia (1999) and (2000).

11. Interest on outstanding credit card balances is not included as a fee since it is related to the credit facility rather than the payment service provided by the card.



Table 2.2 : Fees on ATM and non-cash payment services

	Payer	Recipient	Interchange fees
ATM transaction	Own financial institution: flat fee per transaction (above a specified number)		n.a.
	Other financial institution: flat fee per transaction		Yes
Cheque	Flat fee per transaction (above a specified number)	Flat fee per cheque	No
Direct credit	Flat fee per transaction (above a specified number)	No fee	No
Direct debit	Flat fee per transaction (above a specified number)	Flat fee per item	No
Credit card	Flat annual fee	Fee per transaction (percentage of value)	Yes
Debit card	Flat fee per transaction (above a specified number)	Most pay a fee per transaction (usually flat); some receive a fee.	Yes

their financial institution for debit card transactions, but some large merchants have negotiated arrangements under which they are paid by their financial institution for accepting such transactions.

2.4 PAYMENT CARD NETWORKS

AUTOMATED TELLER MACHINES (ATMS)

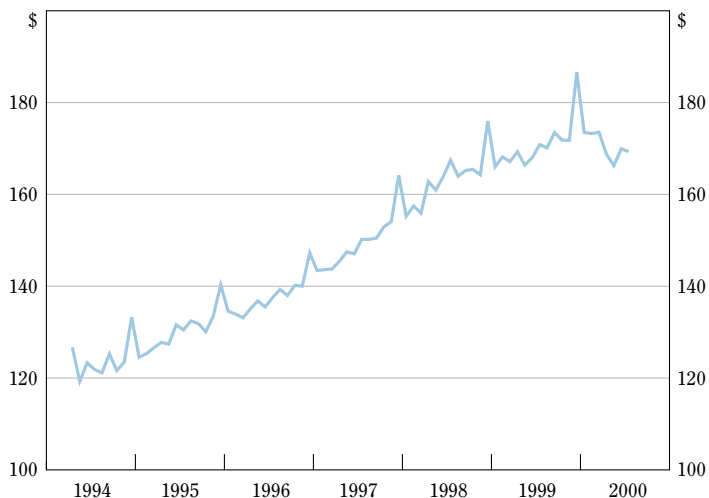
ATMs were introduced into Australia on a wide scale at the beginning of the 1980s. At that time, the banking system consisted of four large nationally operating banks and about half a dozen smaller banks, each operating within the confines of a single state. Building societies and credit unions also serviced narrow regional areas or, in the case of some credit unions, industrial sectors. The development of ATM networks reflected this broad structure. Each of the nationally operating banks constructed a national ATM network for its own cardholders; regional banks did the same within their spheres of activity. Smaller institutions such as building societies and credit unions established joint networks, allowing their customers access to the ATMs of other members of that network.



Customers were issued with debit cards by their financial institution to allow them electronic access to their transaction accounts. Initially, ATMs were installed to provide customers with greater convenience and to encourage transactions away from costly branch operations to this less costly electronic service. The networks remained separate and customers were only able to use ATMs in their particular network. Through the 1980s, however, bilateral agreements between networks began to appear, which allowed customers access to the ATMs of other institutions. These agreements have now spread to allow almost national access to ATMs.

ATMs are well utilised in Australia. Although many machines provide a variety of other services including balance enquiries, deposits, transfers between accounts and ordering of cheque books and statements, they are primarily used for cash withdrawals. Around 37 million withdrawals are made each month at an average of \$170 per withdrawal, up from around \$120 in the mid 1990s (Figure 2.1).

Figure 2.1: Average value of cash withdrawals from ATMs

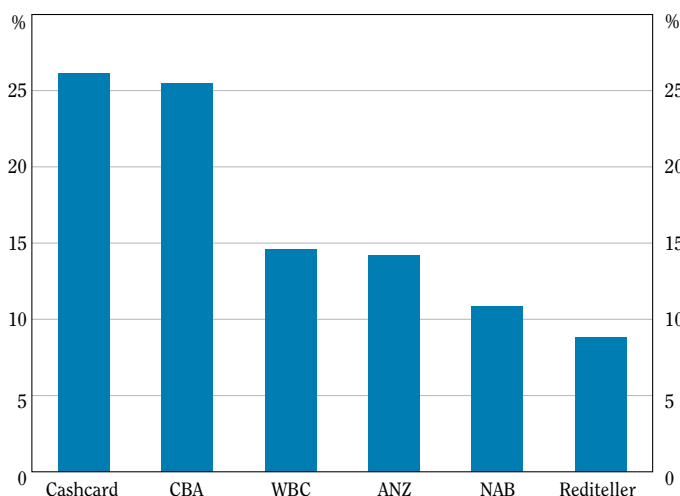


Source: RBA Transaction Cards Statistical Collection

The Cashcard network, which incorporates the large regional banks and a number of other smaller financial institutions, accounts for around one-quarter of ATMs in Australia. The four major banks, as a group, own around two-thirds. The Rediteller network owned by credit unions accounts for most of the remainder (Figure 2.2).



Figure 2.2: Market share of ATMs
1998/1999

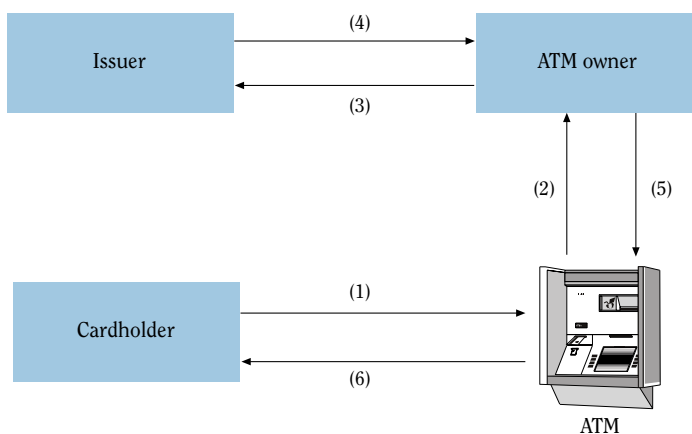


Sources: *KPMG Financial Institutions Performance Survey 1998*; *Commonwealth Bank of Australia Annual Report 1998*; *National Australia Bank Annual Report 1998*; *Westpac Banking Corporation Annual Report 1998*; *Cashcard Australia Limited Annual Report 1999* and *EFT Survey June 1999*.

The processing of an ATM cash withdrawal can involve at least three parties: the cardholder, the financial institution which issues the debit card and the financial institution which owns the ATM. A typical information flow for an ATM cash withdrawal is illustrated in Figure 2.3. The cardholder puts their card into an ATM, enters their PIN and the details of the withdrawal (1); the relevant information is then transmitted to the ATM owner (2). If the ATM owner and card issuer are the same institution, the transaction remains internal to that network. If the card has been issued by another institution, the ATM owner will 'switch' the information to that issuer (3). The issuer then checks if its customer has available funds. If so, it will return an authorisation message via the ATM owner (4) to the ATM (5), and cash is dispensed (6). All this requires only a few seconds.



Figure 2.3: Information flows for an ATM transaction



CREDIT CARD PAYMENTS

There are three main types of cards that allow cardholders to make payments using some type of credit:

- charge cards – general-purpose cards that can be used at all participating merchants. Cardholders have the benefit of an interest-free period, however, the account must be paid in full at the end of the statement period. Examples include the American Express Green card and Diners Club card;
- credit cards – general-purpose cards that can be used at all participating merchants. Cardholders usually have the benefit of an interest-free period if they pay the account in full at the end of each statement period; they also have the option of not paying in full and making use of a revolving line of credit.¹² Credit cards issued in Australia are MasterCard, Visa, Bankcard and the American Express Blue card; and
- store cards – for exclusive use in particular stores. Like credit cards, these generally offer an interest-free period and a revolving line of credit. The store issues the card but will often outsource processing and the provision of credit to a specialist service provider. Examples include the Myer/Grace Bros card and the David Jones card.

As mentioned in Chapter 1, this study focuses on credit cards issued by financial institutions in Australia which have interchange fees. These are MasterCard, Visa and Bankcard. Charge cards do not have interchange fees because their issuers have direct relationships with both the cardholder and the merchant.

12. In this case, the cardholder usually does not receive the benefit of the interest-free period, although this will depend on the cardholder agreement.



Bankcard, a collaboration between Australian banks, was the first credit card to be issued in Australia. Introduced in 1974, it was accepted nationally by 1977. The two international brands, MasterCard and Visa, began to appear in a substantial way in the mid 1980s. The American Express Blue card is a relative newcomer. There are now around 13 million credit cards on issue in Australia.

Estimates of the shares of cards on issue in Australia by the main credit and charge card brands, based on a survey of cards held by respondents, are shown in Table 2.3. Around half of the survey respondents who are over 18 have a credit card. Nearly 60 per cent of respondents with income below average weekly earnings do not have a credit card, and the proportion falls as the income of the main earner rises (Figure 2.4).

**Table 2.3: Market shares of major credit and charge card brands
per cent of cards on issue, 1999/2000**

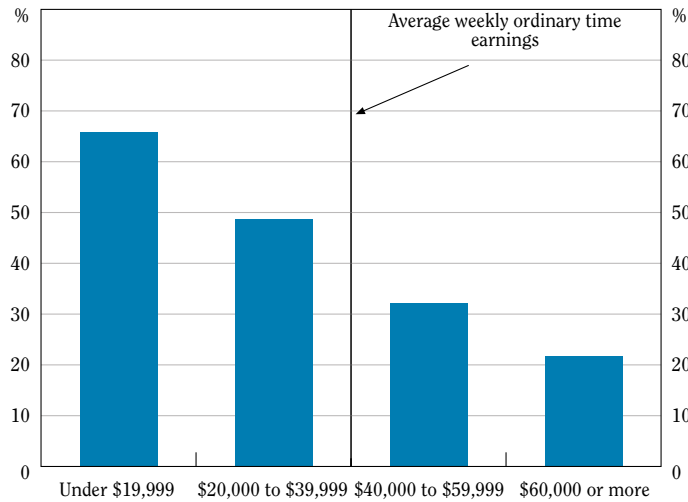
Brand	
Visa	51.4
MasterCard	22.7
Bankcard	19.2
American Express charge card	2.8
American Express credit card	2.2
Diners Club	1.7

Source: Roy Morgan Research

After moderate growth in the early 1990s, credit card usage has accelerated over the past few years, with growth in the number of credit card payments per capita of over 25 per cent in both 1998 and 1999 (Figure 2.5). This acceleration has coincided with the widespread introduction of loyalty programs by credit card issuers and the use of credit cards for a wider range of payments. The number of credit card transactions per month has recently surpassed the number of debit card transactions. The average credit card purchase transaction is around \$100.

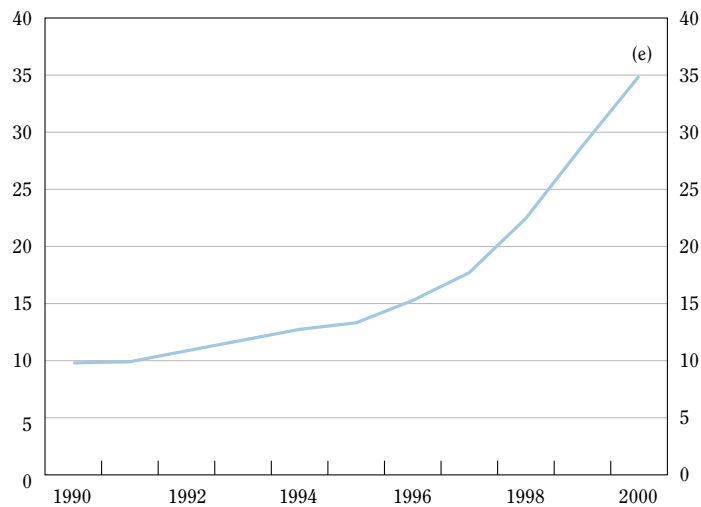


Figure 2.4: Respondents over 18 without a credit card – by income 1999/2000



Source: Roy Morgan Research and ABS Catalogue No. 6302.0

Figure 2.5: Number of credit card payments per capita per year



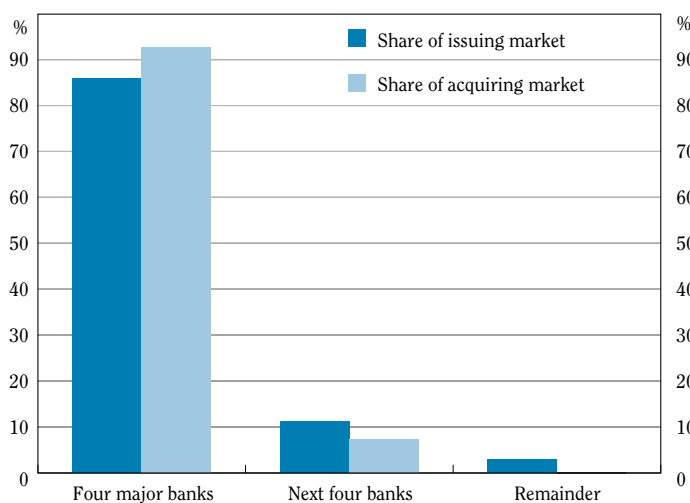
(e) estimated

Source: Reserve Bank of Australia *Bulletin* and ABS Catalogue No. 3101.0



Credit card issuing and the acquiring of credit card transactions are highly concentrated in Australia. Around 85 per cent of credit card transactions involve cards issued by the four major banks, and these same banks account for 93 per cent of credit card transactions acquired (Figure 2.6).

Figure 2.6: Share of credit card issuing and acquiring based on number of transactions, 1999



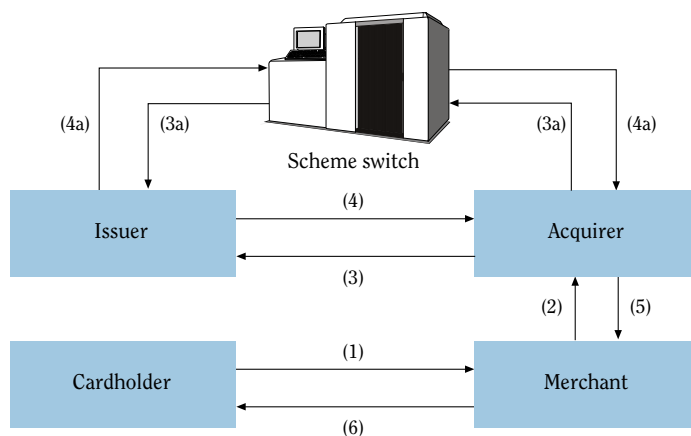
Source: RBA Transaction Cards Statistical Collection

A typical information flow when a credit card is used in an electronic payment transaction at the point-of-sale is illustrated in Figure 2.7. The credit card is swiped through an electronic terminal on the merchant's counter (1). The transaction and cardholder details are routed to the merchant's financial institution (the acquirer) (2). If the acquirer is also the issuer, the transaction can be authorised internally and the authorisation returned to the merchant (5). If the issuer is another institution, the acquirer routes the transaction to that issuer either bilaterally (3) or via a 'switch' facility provided by the credit card scheme (3a).¹³ The issuer either authorises or declines the transaction and a message is sent back to the acquirer, (4) or (4a), and onto the merchant (5). If the transaction is authorised, the customer signs the voucher. The merchant checks the signature against the card and, if all is in order, the transaction is complete (6). When transactions are authorised on-line, as in this example, the cardholder's available credit limit is adjusted immediately, although posting to the cardholder's account can take one to two days.

13. MasterCard and Visa have sites around the world that perform switching and processing for a number of countries.



Figure 2.7: Information flows for a credit card transaction



Credit cards are issued by individual financial institutions, which set the annual fee, interest-free period, the interest rate on the revolving credit facility and other conditions associated with the credit card. The card associations themselves have a number of roles in credit card schemes. At a business level they manage the brand. They establish and maintain rules and regulations covering such issues as membership, governance, technical specifications, procedures for the interchange of transactions and the setting of interchange fees, and dispute resolution. In the case of MasterCard and Visa, the associations also have an operational role that includes switching transactions and calculating what issuers and acquirers owe each other; they may also authorise transactions on behalf of issuers. Finally, they ensure the payment of a transaction if the issuing institution fails by co-ordinating loss-sharing arrangements among surviving members.

DEBIT CARD PAYMENTS

In addition to their use in ATMs, debit cards are used to purchase goods and services, and at many merchants to obtain cash at the time of purchase ('cashback'), by providing the cardholder with electronic access at the point-of-sale to a transaction account at their financial institution.

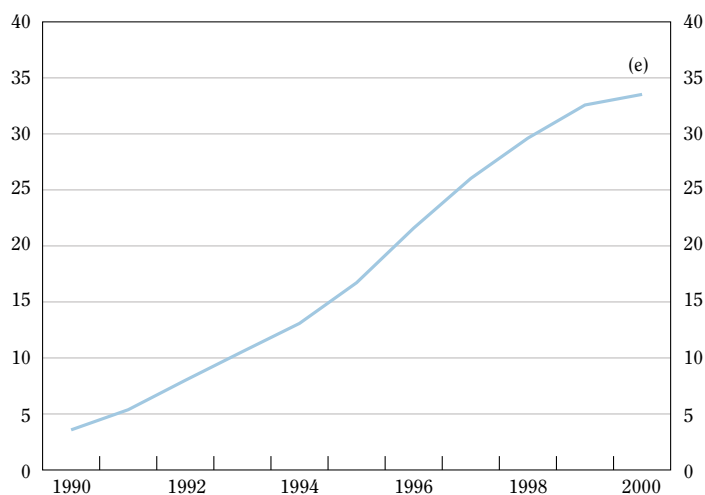
The debit card system developed fairly quickly in Australia over the late 1980s. Initially, it was dominated by the four major banks, which had already issued debit cards for use in ATMs and proceeded to establish proprietary debit card payment networks for these cards. It quickly became apparent, however, that the advantages of an electronic debit card system would be fully realised only if merchants could accept cards from any



institution. Banks therefore began to develop bilateral links between their networks. As more card issuers came into the market, access arrangements had to be negotiated to allow their cards to be used in existing networks. In some cases, new issuers were able to link directly to these networks; in others, they found it more practical to link to one bank that acted as their 'gateway' into the system. Now, financial institutions are linked either directly or indirectly to all debit card payment networks and cardholders can use their cards at any terminal.

Debit card usage in Australia has grown strongly. Since 1994, when the Reserve Bank commenced a regular data collection, the number of debit card payments per capita has increased by 160 per cent (Figure 2.8). Over the past year, however, growth has tapered off at the same time as credit card usage has increased sharply.

Figure 2.8: Number of debit card payments per capita per year



(e) estimated

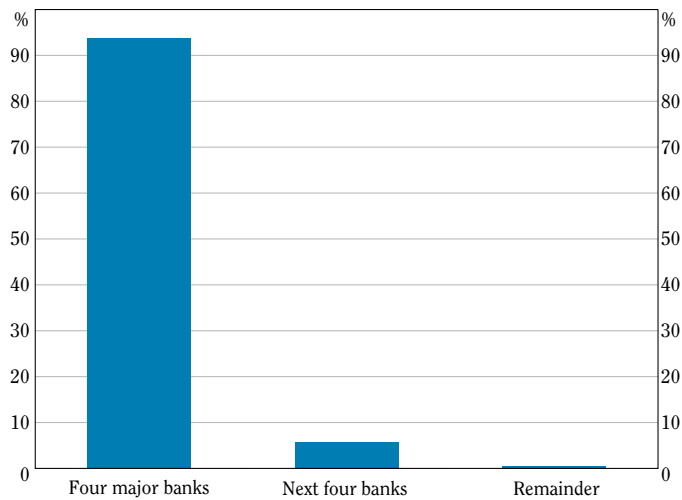
Source: Reserve Bank of Australia *Bulletin* and ABS Catalogue No. 3101.0

At the end of 1999, there were around 294 000 EFTPOS terminals in Australia processing 52 million debit card transactions a month, at an average value of \$58 per transaction. Debit cards are heavily used in supermarkets and service stations in particular.



As with credit cards, acquiring of debit card transactions is a highly concentrated activity in Australia, with the four major banks accounting for almost 95 per cent of the market (Figure 2.9).

Figure 2.9: Share of debit card payment transactions acquired 1999

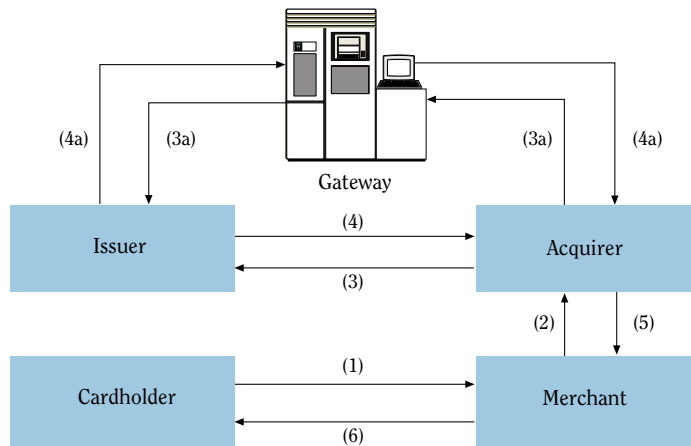


Source: RBA Transaction Cards Statistical Collection

The information flows in a typical debit card transaction at the point-of-sale are illustrated in Figure 2.10. The cardholder presents the card to the merchant and enters a PIN (1), and the relevant data are transmitted to the merchant's financial institution (the acquirer) (2). If it is one of the acquirer's own cards, the account is checked internally and authorisation returned to the merchant (5). If the card is issued by another financial institution, the information is switched to the card issuer either directly via a bilateral link (3) or, if the issuer does not have this link, via a third institution acting as a gateway (3a). The issuer then checks the account and returns an authorisation (or a decline) to the acquirer either directly (4) or via the gateway (4a). The acquirer passes the message to the merchant (5) and the transaction is complete (6). Typically the process is completed in a few seconds.



Figure 2.10: Information flows for a debit card transaction







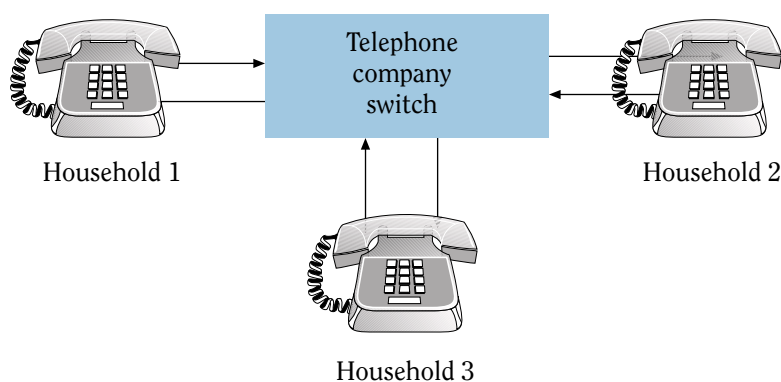
3. PAYMENT NETWORKS AND INTERCHANGE FEES

3.1 NETWORKS AND NETWORK BENEFITS

Debit and credit cards provide services to consumers through what are known as payment networks.

A network is a collection of points or ‘nodes’ that are connected to each other. Industries characterised by networks include telecommunications, the Internet, electricity, water and gas distribution, and payment services. In a telephone system, for example, the nodes consist of households with telephones; the lines and switch technology connecting nodes include wires or other forms of link that can carry the electronic signal of callers’ voices (Figure 3.1). For a non-cash payment system, the nodes represent the four parties normally involved: the payer, their financial institution, the recipient of the funds, and their financial institution. The connecting lines are similar to the telephone system in the case of electronic networks and to the postal system in the case of paper-based systems such as cheques.

Figure 3.1: A simple telephone network



The non-cash retail payments system is not a single network but a series of networks, one for each payment instrument. These networks are not entirely stand-alone but are inter-related from both an economic and a technology perspective. One reason is that payment instruments are substitutes for each other. For example, an increase in the fee for an ATM cash withdrawal may encourage customers to use their debit card to get ‘cashback’ at a point-of-sale terminal instead. Another reason is that the networks use common resources. A reduction in telecommunication costs, for example, will reduce the cost of providing all electronic payment instruments, including on-line debit and credit cards, relative to paper-based instruments such as cheques.



A defining economic characteristic of most networks, at least in their formative period, is that the total value of the network expands more than the value of connection to a new user. A simple example is a single telephone network with three subscribers. If a fourth subscriber joins the network, that person can phone the first three but the first three also benefit because they now have the option of phoning the fourth. As each new subscriber is added, the total value of the network increases by more than the value to the additional subscriber because existing subscribers also gain the benefit of being able to call the new user. This feature is known as a positive network benefit or *externality*, since existing users receive an additional benefit by virtue of the participation of the new user. That is, when a new user joins, everyone benefits.

Network benefits are an important feature of payment networks. Payment cards provide one example. A financial institution may try to encourage the growth of a particular payment network by issuing more payment cards. Merchants that accept those cards all benefit from having a large number of potential customers. Some merchants reluctant to join the network previously may now decide to accept payment cards because they see that the benefits of participation have grown. As more merchants accept payment cards, the benefits to cardholders of having a wider choice of merchants increases, inducing more customers to take up payment cards. The process can become self-fulfilling. A similar process could begin if a financial institution tried to encourage network growth by convincing more merchants to accept payment cards.

Individual participants typically only see, and make decisions in response to, the benefits they perceive for themselves and the price they are charged for these benefits. This balancing of private benefits and costs provides one of the essential market disciplines. Individual participants, however, cannot readily capture the network benefits which are generated when they decide to join a network; these benefits accrue to other participants. Nonetheless, network benefits need to be taken into account if the value of a network to society is not to be underestimated.

3.2 START-UP AND INCENTIVES IN NETWORKS

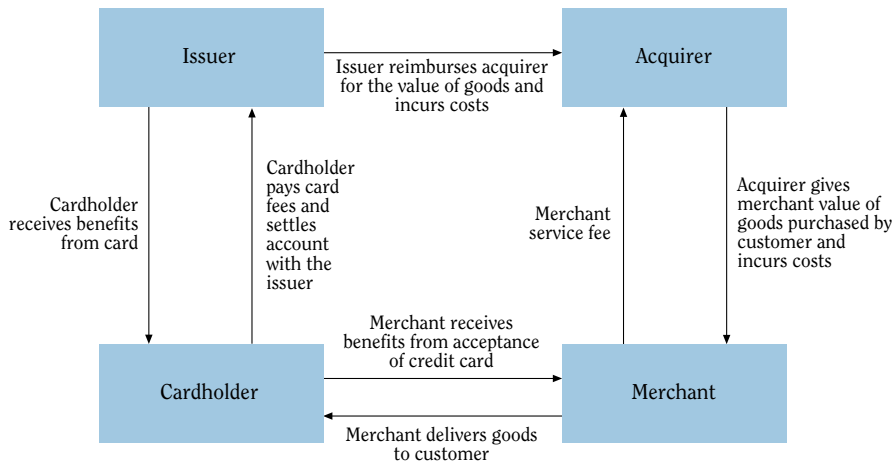
To decide whether to join a network, a participant will weigh up the private benefits and costs of doing so and will join only if, as a minimum, the net benefits are positive. Figure 3.2 illustrates the benefits and costs to participants in a typical credit card network.

Taking the four participants in turn and leaving aside use of the revolving credit facility:

- *a cardholder* obtains private benefits (such as convenience and less need to hold cash) from using a credit card rather than some other payment instrument and pays fees to the issuer for these services. If the fees exceed the private benefits the card will not be taken up. The cardholder's participation also generates externalities in widening the customer base for merchants, but the cardholder does not take



Figure 3.2: Benefits in credit card schemes



these into account – and is not willing to pay for them – because the cardholder does not benefit directly;

- *a merchant* obtains private benefits from accepting credit cards rather than alternative payment instruments (such as reduced cash handling costs) and pays a merchant service fee to its financial institution (the acquirer). If that fee exceeds the private benefits the merchant will not accept the card. The merchant's participation also generates externalities in widening the choices available for cardholders, but the merchant does not take this into account – and is not willing to pay for it – because it does not benefit directly;
- *an acquirer* incurs costs in providing the merchant with acquiring services and receives a merchant service fee. The acquirer will not participate unless the fee exceeds the costs; and
- *an issuer* incurs costs in providing a credit card service and receives a fee from the cardholder. The issuer will not participate unless the fee exceed the costs.

The benefits and costs to each of the participants are summarised in Table 3.1.

Particularly in the formative stage of the network, the net benefits for every participant may not be positive. Cardholders and merchants may underestimate the potential benefits they would receive because they do not take into account the positive network benefits of having a widely used credit card scheme. Issuers and acquirers, in turn, may have substantial start-up costs and will require a critical mass of cardholder and merchant participation to generate sufficient revenue to cover their costs. There is a 'chicken and egg' dilemma in this credit card network, as there is in the start-up phase of most payment networks. Cardholders and merchants have no incentive to join until



Table 3.1: Benefits and costs of a credit card network

Participant	Benefits	Costs
Cardholder	Private and network	Card fees
Merchant	Private and network	Merchant service fees
Issuer	Fees and charges	Card production, credit losses, funding costs, fraud, etc
Acquirer	Merchant service fees	Processing, provision of funds, etc

the network is large enough and the network benefits are realised, while financial institutions have no incentive to participate unless they can cover their costs. The more these institutions seek to cover their costs by charging their customers, however, the less likely are cardholders and merchants to participate.

An interchange fee can help to resolve this dilemma. Provided at least one of the participants perceives benefits in excess of costs, there is scope to share the benefits with other participants through a transfer mechanism. Suppose that merchants are convinced that there are substantial benefits from accepting credit cards but card issuers are reluctant to participate in the network because of high issuing costs. In these circumstances, merchants would be willing to pay a higher merchant service fee, enabling acquirers to capture some of the merchants' net benefits and increase their revenue. If some of this additional revenue can be transferred to issuers, issuers will be more likely to participate. The transfer mechanism is the interchange fee. In this example, the interchange fee would be paid by credit card acquirers to card issuers. Acquirers will only be prepared to pay interchange fees to issuers, however, if their revenue from merchant service fees exceeds their costs *and* the interchange fees (Table 3.2).

**Table 3.2: Benefits and costs of a credit card network
(with an interchange fee)**

Participant	Benefits	Costs
Cardholder	Private and network	Fees and charges
Merchant	Private and network	Merchant service fees
Issuer	Fees and charges <i>plus interchange fees</i>	Card production, credit losses, funding costs, fraud, etc
Acquirer	Merchant service fees	Processing, provision of funds, etc <i>plus interchange fees</i>



3.3 PAYMENTS SYSTEM EFFICIENCY AND INTERCHANGE FEES

A payment network is said to operate efficiently if the net benefits it provides to society are being maximised. As illustrated above, these net benefits may exceed the benefits accruing to individual participants because of the presence of externalities. Since individual participants may not recognise these externalities or take them into account in their own decision-making, incentives may be needed to ensure that the payment network can reach an efficient size. Interchange fees can be one such incentive.

There is a small body of economic literature on the role of interchange fees in payment systems, on which the following discussion draws.¹⁴ The analysis concentrates on credit card networks but is broadly applicable to other card networks as well.

In a simple world with only two payment instruments – say, credit cards and cash – the flows described in Figure 3.2 represent the benefits and costs of using the credit card network instead of cash. The net social benefit would be the total benefits to cardholders, merchants, issuers and acquirers, less their costs. If this is positive, society would be better off if all transactions were by credit card rather than cash. However, each party will participate only if the benefits it receives outweigh its costs; unless it participates, there is no guarantee that the credit card network will develop, leaving cash the only option. An interchange fee which redistributes benefits amongst participants may help to get the network established.

Beyond this simple world, if an interchange fee would help to get a network established, determining the optimal level of that fee is a difficult task, since interchange fees in one network affect participation in competing networks. Take the case of a credit card network in which an interchange fee is paid by acquirers to card issuers. If the interchange fee were passed on to merchants in the form of a merchant service fee, an increase in the interchange fee would reduce the net benefits to merchants from accepting credit cards relative to other instruments. If the net benefits became negative, merchants would choose not to accept credit cards. At the same time, an increase in the interchange fee may also allow issuers to reduce fees paid by cardholders, reducing the cost to them of a credit card relative to other instruments.

However, if merchants can pass the merchant service fee onto customers through higher prices for goods and services, the discipline that merchants can exert on interchange fees is weakened. As a consequence, interchange fees may be set at levels higher than needed to induce issuers to participate, allowing issuers to further reduce fees paid by cardholders. This may encourage the network to expand beyond its optimal size while other networks may not reach their optimal size. Society overall would be the loser,

14. The seminal theoretical article is Baxter (1983). More recent contributions include Rochet and Tirole (1999) and Schmalensee (1999). Frankel (1998) and Balto (2000) provide some contrary views. Some of the arguments used to rationalise interchange fees in the United Kingdom were analysed by Cruickshank (2000).



because resources would not be allocated efficiently. For example, if the interchange fee in a credit card network is above the minimum necessary to generate positive net benefits for all participants, the resulting incentives to use credit cards may direct cardholders away from other payment networks where the net benefit from further expansion might be higher (because, for example, their costs are lower).

The importance of these cross-network effects depends on the extent to which customers can substitute one payment instrument for another. In Australia, a customer using a credit card solely as a payment instrument (ie who does not use the revolving credit facility) would, leaving fees and charges aside, find a debit card to be a close substitute. Debit and credit cards are both widely accepted by merchants and typically use the same terminals and network; merchants do not need to invest in additional equipment to process debit card transactions. For a cash-constrained customer, however, a debit card is unlikely to be viewed as a close substitute for a credit card since it does not offer an automatic credit facility.

While interchange fees can be an incentive for participation in an individual payment network, they can also have significant implications for efficiency and equity in the retail payments system as a whole. The intent of an interchange fee is to ensure that network benefits are taken into account by overriding the usual market mechanisms under which buyers and sellers compare private costs and benefits. While this may be justified in the early stages of development of a payment network, the weakening of normal price signals in a mature network can lead to higher interchange fees than are necessary to establish and maintain the viability of the network.

In a typical market such as, for example, the market for apples, purchasers come into direct contact with sellers and exert downward pressure on prices because they have open to them the relatively simple alternative of trying a different seller, or buying a different type of fruit, if the price of apples is too high. In the market for payment services, however, the end-users – namely the cardholders and merchants – are not involved in determining the interchange fee; the fee is determined by the financial institutions providing the payment services. Cardholders and merchants then face retail charges which reflect the interchange fee. Since the interchange fee is intended to encourage participation in the payment network, the presumption would be that card issuers are acting on behalf of cardholders, and acquirers on behalf of their merchants, when determining the fee. These ‘agency’ arrangements have their strengths and weaknesses:

- their strengths are that they can make negotiations on interchange fees much easier to achieve. For instance, even if a merchant could negotiate an interchange fee directly with issuers of credit cards, the large number of negotiations would make this very difficult; an acquirer representing a number of merchants is also likely to have greater bargaining power than an individual merchant. Similarly, issuers negotiating interchange fees on behalf of a large group of cardholders might be



expected to obtain a better deal than cardholders could achieve as individuals. If agency arrangements are to be an effective way of dealing with these difficulties, however, it is important that the agents face incentives to act in the interests of their customers; but

- their weaknesses are that, to the extent that financial institutions can pass interchange fees onto their customers, they may have no direct incentive to keep these fees low. In a well-established credit card network, for example, the only option available to most merchants unwilling to bear a merchant service fee based on a high interchange fee would be to cease accepting credit cards. As a unilateral action, this could put them at a serious competitive disadvantage. In this case, the interchange fee can be passed on by the financial institutions in the card scheme to merchants without difficulty (at least up to a point) because merchants have only limited and costly means to avoid it.

The implications are that the price signals which guide resource allocation, and the normal market discipline exerted by users, may not be effective in payment networks which have interchange fees. Once payment networks become well-established, the role which an interchange fee might play in ensuring that network benefits are reaped therefore needs to be weighed against any resource costs from shielding the networks from competitive disciplines. This assessment may be different for ATM, credit and debit card networks.

Interchange fees in payment networks can also have implications for equity. If, for example, interchange fees in a credit card network are increased and passed on in full to merchants through the merchant service fee, merchants' costs would rise for a given level of credit card usage. To recover these costs, merchants would raise the price of goods and services charged to customers. As a result, the increase in interchange fees is ultimately borne by *all* customers, not just those who pay with credit cards. Card users would be subsidised by those who do not use credit cards.

3.4 INTERCHANGE FEES AND COSTS

The general framework of payment networks provides a rationale for an interchange fee, but does not indicate the direction in which such a fee might flow, its size or how it should be calculated. Specific interchange fee arrangements would depend on the circumstances of individual payment networks.

In practice, there are two main approaches used to determine an interchange fee. The first approach views an interchange fee as the means by which financial institutions recover the costs of providing a card payment service from those who are the beneficiaries of the network. To apply this approach, the costs incurred by card issuers and acquirers need to be identified and those costs that could be recovered directly from cardholders or merchants excluded from calculation of the interchange fee. The remaining costs form the basis for interchange fee negotiations. Once these costs have



been identified, it would be clear whether they are related to the number of transactions (in which case the interchange fee would be a flat fee) or to the value of the transaction (in which case it would be a percentage of value).

This first approach involves judgments about who are the beneficiaries of the payment network and the costs incurred in providing the various benefits. It also involves judgments about the level of costs which can be recovered directly from cardholders or merchants without discouraging them from participating in the system.

The alternative approach used is to assess whether the revenues earned by issuers and acquirers from their own customers are adequate to cover costs for both parties. If not, an interchange fee may help by redistributing revenues. If one of the two parties (issuers or acquirers) has an excess of revenues over costs and the other a shortfall, that shortfall would determine the minimum interchange fee.

This second approach is illustrated in Table 3.3. In this example, acquirers earn net revenues of 60 units while issuers have a revenue shortfall of 20 units. A minimum interchange fee of 20 units would be needed to enable issuers to break-even and induce them to participate. (This approach makes no distinction between costs related to the value of the transaction and those that are not.) Within this second approach, an interchange fee could also be used instead to ensure that net revenues of the card network are shared equally. The network generates total revenues of 180 units and incurs total costs of 140 units, leaving net revenues of 40 units. Sharing these equally between issuers and acquirers would imply an interchange fee of 40 units paid by acquirers to issuers, leaving both parties with net revenues of 20 units. These examples are merely illustrative and do not take into account the capital committed by issuers and acquirers.

Two additional comments can be made about the calculation of interchange fees in practice. First, the level of the interchange fee will determine whether the main incentive is to encourage acquiring or card issuance. In the case of credit cards, for example, the interchange fee – and hence the merchant service fee – might be set

Table 3.3: Illustrative interchange fee calculations

Acquirers		Issuers	
Costs	40	Costs	100
Revenues	100	Revenues	80
Net	60	Net	-20



lower for all transactions than a formal methodology would suggest to encourage merchant acceptance of credit cards, or lower for certain classes of transactions to attract new categories of merchants into the card scheme. Alternatively, the interchange fee might be set higher to encourage card issuance. Such adjustments obviously have implications for how much of the scheme's costs are ultimately borne by cardholders and consumers more generally.

Secondly, interchange fees are normally calculated on the basis of average (or total) revenues and costs. The focus on average costs derives from the economic characteristics of most payment networks. Payment networks tend to involve significant set-up costs; once established, however, the per unit cost of providing payment services falls sharply as usage of the network increases. In electronic payment systems, for example, substantial fixed costs may be incurred initially but the marginal cost of electronic messages is relatively low and constant. Where such economies of scale exist, average costs are likely to exceed marginal costs and cost recovery based on marginal cost calculations will produce revenue streams that do not cover total costs.

Payment networks also tend to involve the joint provision of services, often with shared overheads. For example, a financial institution offering a transaction account will usually include a debit card as part of the service. Similarly, debit and credit card payment facilities are sometimes accessed using the same card, and the cost of producing and distributing these cards is a joint one. In these circumstances, directly attributable costs are likely to understate costs because they do not allow for overhead and joint costs of providing a payment service.

The use of average costs in interchange fee calculations makes allowance for high fixed costs and for the allocation of joint and overhead costs to specific payment services. For example, in estimating the costs of providing an ATM service, financial institutions will count direct costs such as depreciation, maintenance of the machine and transmission of electronic messages, and will typically allocate indirect costs such as a share of the institution's technology support, senior management costs and personnel overheads.





4. ATM NETWORKS

4.1 FEES AND COSTS

In Australia, financial institutions that own ATMs are also card issuers, and they offer ATM services to their own cardholders and the cardholders of other institutions.¹⁵ The provision of ATM services, whether to their own cardholders or others, involves a range of costs. There are infrastructure costs associated with the establishment and maintenance of the ATM network, as well as variable costs associated with stocking the machines with cash, the interest foregone on this cash (often known as ‘float’), and processing and switching transactions. Financial institutions seek to recover these costs, and earn a return on the capital involved, through some form of charging.

In the case of their own customers, financial institutions normally treat access to ATMs as an integral part of a transaction account. The costs of providing that account are recovered through account maintenance fees, payment of below-market rates of interest on balances and transaction fees, which normally allow a number of fee-free transactions per month. Around 30 per cent of ATM transactions, however, are undertaken by customers of other financial institutions. In such cases, ATM owners have no account relationship with the customer and they seek to recover their costs in other ways.

A card issuer wanting to provide its cardholders with access to the ATM network of another financial institution negotiates an interchange agreement with that institution. The agreement covers matters such as the authorisation of transactions and technical procedures, and includes an interchange fee to be paid by the issuer to the ATM owner. The interchange fee is the wholesale price of access to the ATM network, and is designed to reimburse the ATM owner for costs incurred in providing a service to the issuer’s customers. Payment of such interchange fees is common in many other countries.

There are almost 60 bilateral ATM interchange agreements in Australia, and the interchange fees vary from agreement to agreement.¹⁶ Figure 4.1 shows the distribution of interchange fees contained in the agreements for the main uses of an ATM – cash withdrawals and balance enquiries – based on information provided to the study. Total ATM interchange fees paid to ATM owners in 1999 amounted to around \$230 million.

Fees for cash withdrawals are, for the most part, higher than for balance enquiries. For withdrawals, the fees usually fall between \$0.90 and \$1.10, with an average of \$1.06, while for balance enquiries most fees fall between \$0.60 and \$0.80, with an average of

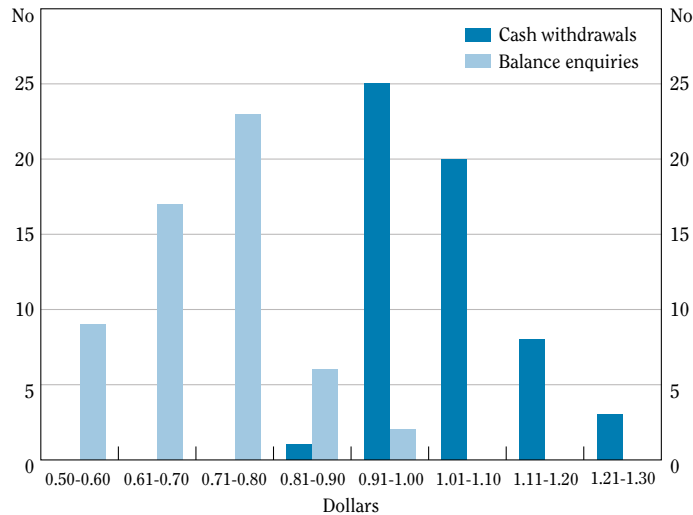
15. In addition, there are some non-financial institutions that own ATMs.

16. Within each agreement, the interchange fee is the same for all transactions of a certain type (eg cash withdrawals) initiated by the issuer’s customers, no matter where in Australia the ATMs are located.



\$0.74. Bilateral agreements for ATMs are ‘knock-for-knock’ – that is, the interchange fee between any pair of institutions is the same regardless of which one is the issuer.

Figure 4.1: Interchange fees for ATM transactions
Number of agreements



ATM interchange fees have changed little since they were introduced, many in the 1980s. The study was advised of only 15 adjustments, several arising out of a change in relationship between the two institutions involved. For example, a merger of two financial institutions, each with separate interchange agreements, usually resulted in a renegotiation of interchange fees with other institutions.

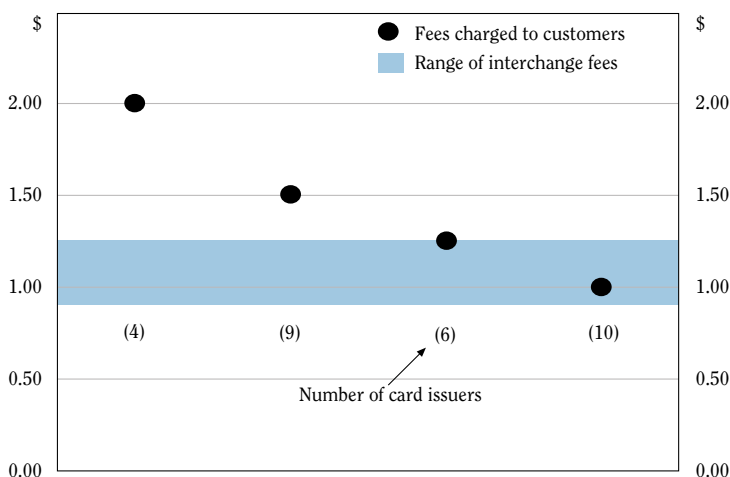
The interchange fee paid to the ATM owner is normally passed on by the issuer to its cardholders in the form of a ‘foreign ATM fee’. Figure 4.2 shows the foreign ATM fees charged by a sample of financial institutions that issue debit cards, compared with the range of interchange fees paid in the industry. Around half of the institutions shown charge their customers more than the maximum interchange fee they pay, often substantially more; in the remaining cases, cardholders are charged a rate in line with interchange fees. On average, the foreign ATM fee is around \$1.35.

Data on the costs of providing ATM services were supplied to the study by a group of financial institutions, including the four major banks and some smaller institutions; together, this group accounts for 97 per cent of ATMs in operation. The data are for the year 1999. The main costs, expressed as average costs per transaction, and the range of costs are shown in Table 4.1.¹⁷

17. In the interests of preserving confidentiality, one outlier observation has been excluded but this does not change the weighted average cost.



Figure 4.2: Foreign ATM fees and interchange fees – cash withdrawals



Source: CANNEX Australia and information provided to the study.

The average cost of an ATM withdrawal is just under \$0.50, and around 85 per cent of transactions take place at ATM networks with an average cost of under \$0.60. Within the cost categories, there are some wide variations but many have a ready explanation:

- *Cash handling costs.* Some institutions were unable to separate their own staff costs from third-party staff costs. In some cases the costs of own staff were included in cash handling while in others they were included in support staff. This affects the figures in these categories but not the total.
- *ATM cash float.* The schedules on which ATMs were stocked appeared to have an impact on these costs: fixed schedules are apparently more expensive in terms of float cost than more flexible schedules. However, there may be an offset in cash handling costs if flexible schedules result in more frequent stocking.
- *Switch costs.* Some institutions were unable to separate their own switch costs from processing costs, and included both items in processing.
- *Depreciation.* Some institutions included only ATMs in their depreciation costs while others also estimated depreciation for associated infrastructure such as the network switch. The age of machines also had an impact, with older networks generally reporting a lower depreciation cost.
- *Site rental.* Institutions reported only explicit rental costs for off-site ATMs. Institutions with a large proportion of off-site terminals compared to terminals in or on the outside of their own branches typically reported higher rental costs per transaction.



Table 4.1: ATM cash withdrawal costs per transaction*
(\$A)

	Range	Weighted average
Operating expenses	0.17-0.42	0.26
Of which		
Cash	0.03-0.25	0.13
• Cash handling	0.05-0.18	0.10
• ATM cash float	0.03-0.08	0.05
Other	0.06-0.19	0.13
• Processing	0.02-0.09	0.04
• Switch costs	0.01-0.05	0.02
• Installation and maintenance	0.03-0.15	0.08
Overheads	0.15-0.36	0.24
Of which		
• Support staff	0.01-0.17	0.04
• Site rental (off premise)	0.01-0.07	0.03
• Depreciation/leasing	0.05-0.15	0.08
• Telecommunications	0.03-0.07	0.04
Cost per transaction	0.42-0.63	0.49
Interchange fee revenue	0.80-1.10	1.03

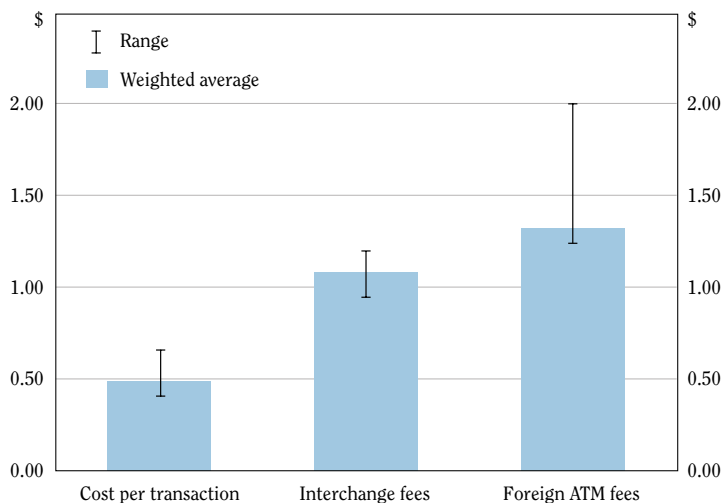
* Because of the weighting process, the components of average costs and revenues do not necessarily add to the total. Adding the maxima for each component may also give a figure that is higher than the maximum total cost shown because the maximum in each component is accounted for by different institutions.

The evidence suggests that interchange fees are a substantial mark-up on the costs of providing ATM services. For *cash withdrawals*, the weighted average cost, interchange fee and foreign ATM fee are shown as columns in Figure 4.3; the lines represent the ranges. Interchange fees paid to ATM owners average a little over \$1.00 for cash withdrawals, which is double the average cost.¹⁸ Card issuers pass these fees on in full

18. The Cruickshank report, *Competition in UK Banking*, also concluded that interchange fees for ATM transactions in the United Kingdom were often not related to cost. The report estimated the average cost of an ATM cash withdrawal at 30p compared with interchange fees as high as 60-70p for those institutions that do not own any ATMs.



Figure 4.3: Costs, interchange fees and foreign ATM fees – cash withdrawals



Sources: CANNEX Australia and information provided to the study.

to customers using the ATMs of other financial institutions, and many issuers add a further margin. Had they used ATMs from their own financial institution, and incurred an ATM withdrawal fee (ie had exceeded the maximum number of fee-free transactions), they would face a fee much more in line with costs. This fee averages around \$0.60 and ranges from \$0.50 to \$1.00 for most customers.

In the case of *balance enquiries*, interchange fees also represent a substantial mark-up over costs. Table 4.1 suggests that, if the costs of cash (stocking and float) are excluded, the weighted average cost of processing a balance enquiry is around \$0.36. The average interchange fee for balance enquiries is \$0.74, double the average cost. Most card issuers add a further margin when passing this fee on to customers; many in fact charge the same foreign ATM fee for balance enquiries as for cash withdrawals, even though the interchange fees for these two types of transactions are different.

In other words, ATM owners earn substantially more revenue from ATM services supplied to customers of other financial institutions than they do from transaction fees on their own customers. As a consequence, although interchange fees paid and received offset each other for the network as a whole, cardholders who use ATMs of another financial institution generate a stream of net revenue for financial institutions. A large financial institution that is both a significant issuer and acquirer is a microcosm of the industry. Its flow of interchange fees paid and received would largely cancel out, but it would be reimbursed by its customers for all the interchange fees it paid.



Some of the margin between ATM interchange fees and costs could represent the required return on capital. The study attempted to take this into account and approached a number of institutions to understand how they allocate capital to the provision of ATM services and determine what the required rate of return was; however, none were able to provide any figures. One of the main reasons offered was that ATMs are owned by financial institutions primarily as a distribution channel for their own customers and form part of the provision of transaction accounts; separating ATM services from the broader account relationship was very difficult.

In principle, however, it should be possible to treat the provision of ATM services as a stand-alone business and allocate capital against the risks in this business. The main risk is operational risk (the risk of breakdowns and associated loss of reputation), which is difficult to measure. Taking as a proxy the value of ATM infrastructure (based on depreciation figures provided to the study) and using the average capital ratio for the banking sector, some very preliminary figuring would suggest that a margin over costs of only a few cents per transaction would yield a competitive rate of return on capital for the provision of ATM services.

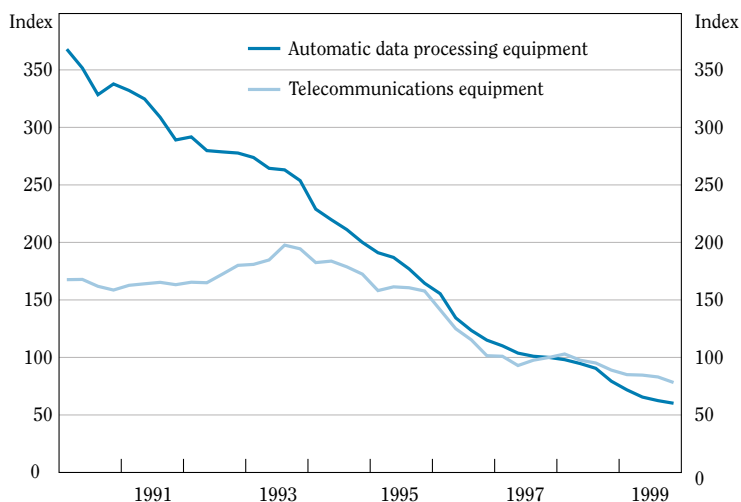
Another aspect of interchange fees which is of interest is whether these fees have varied over time to reflect changes in costs. The evidence suggests that this is not the case because ATM interchange fees have been largely unchanged over the past decade. Although the study did not collect data on costs over a run of years, there are good reasons to believe that some important components have fallen appreciably. For instance, ATMs themselves have become cheaper; ATMs at the upper end of the range are now much more sophisticated machines, capable of undertaking a variety of functions, and a number of more basic, low-cost machines are available. In addition, processing and telecommunication costs have fallen substantially. The implicit price deflator for data processing and telecommunications equipment, which allows for increases in equipment quality, is shown in Figure 4.4. Data processing equipment has improved to such an extent that the cost of purchasing a given quality (speed, power, memory etc) in 1999 was one-sixth of its cost at the beginning of the decade. Over the same period, the cost of telecommunications equipment has fallen by around one half.

The cost to ATM owners of keeping their machines stocked with cash has also declined as interest rates have fallen. In the late 1980s when interchange agreements were first set up, the cash rate – the rate at which ATM owners could have invested the cash they hold in ATMs – averaged 15 per cent per annum. Over the second half of the 1990s, in contrast, it averaged 6 per cent. Other costs of providing ATM services are linked, directly or indirectly, to staff costs. Over the past decade, broad measures of staff costs have risen by around 50 per cent.

In short, if ATM interchange fees were initially based on costs, they have not shown any flexibility in responding to costs in recent years.



Figure 4.4: Prices of data processing and telecommunications equipment
(1997/98 = 100)



Source: ABS Catalogue No. 5302.0.

4.2 COMPETITION IN ATM SERVICES

The substantial margin between ATM interchange fees and costs could be expected to attract new entrants into the provision of ATM services. Although there have been some new entrants, neither these nor competition between the established providers have created any discernible downward pressure on interchange fees. This raises some questions about the nature of competition in the provision of ATM services in Australia.

Because only two parties rather than a larger group are involved, there is no reason in principle why bilateral ATM interchange agreements could not be flexible and responsive to changes in the costs of providing ATM services. In a competitive market, issuers seeking to increase their market share should look to establish agreements with the lowest cost providers of these services. Similarly, owners of ATM networks wanting to increase usage of their terminals, and hence their revenues, should compete to attract issuers into interchange agreements. Provided both parties had comparable bargaining power and agreements could be re-negotiated without difficulty, competitive pressures would be expected to produce interchange fees which reflect the costs of providing ATM services, including a return on capital.

In practice, bilateral price setting has not delivered this outcome. As explained above, most ATM interchange fees were set about a decade ago and few have been adjusted, despite significant changes in important cost components.



A major explanation for the fact that interchange fees have not fallen is that there are no clear incentives for financial institutions to negotiate lower fees. For financial institutions as a whole, interchange fees are not a cost; fees paid and received net out to zero, but institutions receive a flow of revenue from foreign ATM fees. Cardholders have the strongest interest in lower interchange fees but cannot influence ATM owners directly. They do not see the interchange fee; they only see the foreign ATM fee. Under current arrangements, their only alternative is to restrict withdrawals to their own institution's ATMs or to undertake the costly process of moving their transaction account to another institution which charges lower foreign ATM fees. Under these circumstances, it is relatively easy for card issuers to pass on the whole cost (or more than the whole cost) of the interchange fees to their cardholders.

The structure of interchange fees is not monolithic; it is the result of a large number of bilateral negotiations which have yielded the range of outcomes shown in Figure 4.1. This structure might be thought to provide for competition among the different financial institutions. However, the bargaining power of participants negotiating ATM interchange agreements favours large financial institutions over smaller new entrants. Owners of large ATM networks, for example, are likely to be at a competitive advantage compared to small issuers. Each issuer needs to provide its cardholders with wide access to ATMs to compete successfully for deposits. A small issuer will want to establish an interchange arrangement with at least one large ATM network. The owner of a large ATM network, however, has much less to gain from such an agreement since it will not bring in a significant number of new ATM users, and the owner is under no great pressure to compete for the business of small issuers.

Similarly, large card issuers may have a potential advantage over new and smaller ATM owners. To build up a user base of any significant size, a new ATM owner would need to establish an interchange arrangement with at least one large issuer. However, there may be little pressure on a large issuer to reach agreement since its cardholders, which presumably have a wide choice of ATM networks already, may gain little benefit from access to an additional, small ATM network.

A final reason why ATM interchange fees have been inflexible is that bilateral interchange agreements are not easy to re-negotiate. Re-negotiation typically creates a winner and a loser. The loser naturally prefers the status quo so unless the winner chooses to force the issue through its greater bargaining power, the interchange fee will not change. Once its cardholders have become used to the convenience of access to a wider ATM network, the issuer – whatever its bargaining power – may find it difficult to walk away from the agreement.

The evidence provided to the study is consistent with the view that bargaining power is unequal. In the few cases in which ATM interchange fees have fallen, the negotiations usually involved a larger issuer; where interchange fees have risen, the ATM owner was relatively large.



4.3 AN ALTERNATIVE TO INTERCHANGE FEE ARRANGEMENTS

Although interchange fees are the predominant means by which ATM owners around the world are recompensed for providing services to cardholders of other institutions, there are other alternatives available. For example, they could choose to charge such cardholders directly at the time the transaction is undertaken. Under this form of ‘direct charging’ regime, each ATM owner would decide how much to charge. For example, on a \$100 withdrawal the ATM owner would dispense \$100 to the cardholder but would claim \$100 plus its fee from the cardholder’s financial institution, which would debit the cardholder’s transaction account for that full amount. Such arrangements are now relatively common in the United States where they are described as ‘surcharging’.¹⁹

There are no impediments to direct charging in Australia but it is not used for ATM services. However, if more non-financial institutions were to enter the ATM business, it could focus attention on this alternative pricing regime. There are a number of institutions, including retailers, cash distribution companies and payment processing companies, interested in owning ATM networks but which do not issue debit cards. These institutions would treat the provision of ATM services as a discrete business and will be seeking ways of recouping costs and earning a return on capital.

The attractions of a direct charging regime are that it may encourage transaction fees more in line with costs, and promote transparency. For a start, it puts the ATM owner in a direct economic relationship with the cardholder, rather than only an indirect one via the issuer. If the consumer is to exert any direct influence on pricing – for example, by patronising the less expensive ATMs – this regime would achieve it more effectively than the present system.

As an additional factor, under current arrangements the ATM owner receives the same interchange fee for an ATM withdrawal from a given issuer, regardless of where that transaction is undertaken. High-cost locations are therefore subsidised by low-cost ATMs. Under a direct charging regime, in contrast, ATM owners could vary the transaction fee according to the per unit cost of individual machines. This would provide an incentive to place more ATMs in higher cost (eg remote) locations, offering greater convenience for consumers willing to pay. In the United States, for example, the advent of direct charging has resulted in an increase in the number of ATMs, particularly in high-cost locations.²⁰

Direct charging would also make transaction charges obvious to ATM users. The lack of transparency of foreign ATM fees has been a matter of concern in Australia for some

19. This term is used because the ATM owner in the United States typically receives two fees: an interchange fee as well as the direct charge to the customer. If the customer’s financial institution passes the interchange fee through to the customer, the customer also pays two fees – one levied directly by the ATM owner and the other by their own financial institution.

20. See McAndrews (1998).



time.²¹ Under a direct charging regime, ATM owners could charge the same transaction fee at a particular ATM to customers of any other financial institution. In this case, it would be relatively straight-forward to 'post' that fee on the ATM so that users can see the cost of a transaction before they undertake it. (In principle, that same fee could apply to customers of the ATM owner as well, subject as at present to a number of fee-free transactions.)

A direct charging regime is unlikely to be compatible with interchange fees. Both are mechanisms for recovering the cost of providing ATM services from users. An ATM owner fully recovering its costs through a fee directly from the cardholder would be double dipping if it also sought an interchange fee.²²

CONCLUSIONS

- *Interchange fees for ATM services are around double the average cost of providing these services. This margin cannot readily be explained by the need of ATM owners to earn a competitive return on capital.*
- *Foreign ATM fees can be higher again since many card issuers impose an additional margin, which can be particularly wide for balance enquiries.*
- *Interchange fees have been largely unchanged for many years and show little responsiveness to changes in major components of costs.*
- *There are few incentives for existing ATM owners and card issuers to negotiate lower interchange fees. New entrants so far have had little impact.*
- *Interchange fee arrangements are the most common basis for recouping costs of providing ATM services to customers of other financial institutions but are not essential to ATM networks. ATM owners could seek to recover their costs by charging customers of other financial institutions directly ensuring a direct economic relationship between these customers and ATM owners.*

21. The transparency of ATM charges is currently under review. The first draft update of the EFT Code of Conduct prepared by the Australian Securities and Investments Commission (ASIC) included a requirement that receipts issued from ATMs show the fee, if any, applicable to the transaction. Banks have argued that such a requirement is unworkable at this stage and the requirement was removed from the second draft. The Parliamentary Joint Statutory Committee on Corporations and Securities is currently enquiring into bank fees on electronic transactions, including the issue of disclosure.

22. The centralised ATM network in the United Kingdom (LINK) has recently announced that ATM owners that levy fees on cardholders will not be able to collect interchange fees as well. In the United States, on the other hand, direct charges are typically an addition to interchange fees.



5. CREDIT CARD NETWORKS

5.1 FEES AND COSTS

Interchange fees in credit card schemes are paid to the card issuer by the merchant's financial institution (the acquirer) whenever the merchant accepts a credit card for payment. In Australia, interchange fees for domestic transactions (ie transactions between two Australian members) are agreed jointly by the financial institutions which are members of each of the card schemes. The interchange fees for MasterCard and Visa are 0.8 per cent of the value of the transaction for transactions that qualify as electronic and 1.2 per cent for other transactions. The interchange fee for Bankcard is 1.2 per cent for all transactions.²³

In 1999, the amount of interchange fees paid to credit card issuers in Australia was in the order of \$550 million.

Credit card interchange fees in Australia are not reviewed regularly by scheme members on the basis of any formal methodology.²⁴ Interchange fees for MasterCard and Visa were last changed in the early 1990s. Australian members of each of the two schemes commissioned a review of the respective fees in the mid 1990s but no changes to fees resulted. Interchange fees for Bankcard have not changed since 1974.

Data on credit card costs and revenues were supplied to the study by the four major banks and some smaller institutions; together, these institutions account for around 95 per cent of credit card transactions in Australia. These data, which are for the year 1999, show that the average interchange fee per transaction received by card issuers is \$0.95. Since the average credit card payment is around \$100, this per transaction figure can also be interpreted as a percentage (ie 0.95 per cent), reflecting the inclusion of electronic transactions normally at 0.8 per cent and other transactions at 1.2 per cent.²⁵ Acquirers pass this fee on in full to their merchants together with a margin, also typically calculated as a percentage of the value of the transaction, to cover the costs of providing acquiring services. The resulting merchant service fee averages \$1.78 per transaction (or 1.78 per cent).

23. Australian Competition and Consumer Commission, *Statement of Claim*, Federal Court of Australia, September 2000.
24. This contrasts with the United States and Europe, where the study understands MasterCard conducts full reviews on an annual basis.
25. For individual institutions, however, the average credit card payment ranges from \$80 to \$130; hence, the per transaction figures reported in the ranges cannot simply be converted to percentages.



Costs and revenues from the provision of credit card services are summarised in Table 5.1. The data include both paper and electronic transactions and so figures are an average of the two.²⁶

The range of costs for both acquiring and issuing is quite wide. There are some partial explanations for these ranges:

- with the costs involved in acquiring paper transactions higher than for electronic ones, institutions which process a higher proportion of paper transactions than others will have higher costs;
- newer credit card networks with the associated costs of set-up and expansion reported higher depreciation costs than older networks; and
- the allocation of staff costs is not consistent across institutions. Some allocated staff costs for specific activities to the relevant activity, leaving only overhead staff costs in the 'staff' category. For others, all staff costs were included in this category.

In addition, the data provided show a difference in the average interchange fee paid by acquirers (\$1.06) and received by issuers (\$0.95). The explanation is not obvious; it may relate to differences in the proportion of electronic and paper-based transactions captured in the information provided by acquirers and issuers, and to the inclusion of international transactions, which attract different interchange fees, in the data.

The evidence shows that credit card issuing and acquiring in Australia generate revenues well above costs. In the case of credit card *issuing*, costs average \$1.93 per transaction but total revenues average \$2.69, a mark-up over costs of \$0.76 or 39 per cent. The main sources of revenue are:

- the margin between the interest received from cardholders who make use of the revolving credit facility and the cost of funds. This interest margin accounts for just over half of total revenues;
- interchange fees, which account for a further third of the total; and
- annual fees, which account for just over 10 per cent of total revenues. Cardholders typically pay an annual fee of between \$18 and \$30 for most standard credit cards with an interest-free period. This fee is typically waived on credit cards without an interest-free period.

The continuing drive for new cardholders – particularly through the inducement of loyalty points – is one sign of the margins available in credit card issuing. Loyalty schemes are not included in Table 5.1 because they are not a resource cost. Card issuers pay an average of \$0.46 per transaction, and a range of \$0.30 to \$0.62 per transaction, for benefits provided to cardholders in loyalty schemes.

26. In the interests of preserving confidentiality, two outlier institutions have been excluded from the table – one on the low side and the other on the high side. If these institutions were included, the weighted average cost would be \$0.44 for acquiring and \$1.98 for issuing.



**Table 5.1: Credit card costs and revenues per transaction*
(\$A)**

	ACQUIRING			ISSUING	
	Range	Weighted average		Range	Weighted average
COSTS					
Operating Expenses	0.08-0.31	0.19	• Production/distribution of cards	0.01-0.13	0.06
Of which			• Authorisation	0.03-0.05	0.04
• Staff	0.01-0.14	0.07	• Processing	0.05-0.38	0.17
• Authorisation	0.01-0.15	0.04	• Staff	0.05-0.82	0.39
Data processing	0.02-0.11	0.04	• Interest-free period	0.14-0.32	0.26
Switching services	0.01-0.10	0.03	• Fraud	0.05-0.09	0.07
Overheads	0.13-0.35	0.24	• Credit losses	0.20-0.41	0.35
Of which			• Other	0.11-1.41	0.68
• Depreciation	0.03-0.13	0.07	Cost per transaction	1.06-2.59	1.93
• Telecommunications	0.03-0.07	0.05			
• Fraud	0.01-0.06	0.01			
• Other	0.00-0.21	0.11			
Cost per transaction	0.27-0.63	0.43			
Interchange fees paid	0.92-1.21	1.06			
REVENUES					
Merchant service fees	1.55-2.37	1.78	• Interest margin	0.60-1.80	1.36
			• Interchange fees	0.81-1.05	0.95
			• Annual fees	0.12-0.53	0.33
			• Other	0.00-0.15	0.05
			Revenue per transaction	1.53-3.10	2.69

* Because of the weighting process, the components of average costs and revenues do not necessarily add to the total. Adding the maxima for each component may also give a figure that is higher than the maximum total cost shown because the maximum in each component is accounted for by different institutions.



In the case of credit card *acquiring*, costs average \$0.43 per transaction but fee revenues, after interchange fees are passed on to issuers, average \$0.72. This is a mark-up over costs of \$0.29 or around 67 per cent.

The margins between revenues and average costs have not incorporated a return on the capital committed to credit card issuing and acquiring. The study approached a number of institutions to understand how they allocate capital to these activities and what their required rate of return was. The institutions were generally unable to supply suitable data on this score. Only one institution provided a detailed methodology on how capital was allocated to credit card issuing and acquiring; one other institution provided some data on the cost of capital for credit card issuing.

In credit card issuing, the main risks against which capital would be held are credit risk (the risk of default by cardholders with balances outstanding) and operational risk (fraud and breakdowns in network infrastructure). Taking as a proxy for these risks the value of credit card lending outstanding, and using average capital ratios for the banking sector, some very preliminary figures would suggest a margin over costs in the order of \$0.30 a transaction would provide a competitive rate of return on capital for credit card issuing.

A return on capital in credit card acquiring is more difficult to determine because this activity is usually seen as part of the same business as debit card acquiring. In credit card acquiring, where credit risk is minimal, the main risk is operational risk which is hard to measure. Taking as a proxy the value of credit card infrastructure (based on depreciation figures provided to the study), very preliminary figuring would suggest that a margin over costs of only a few cents per transaction would provide a competitive rate of return on capital for credit card acquiring.

5.2 DETERMINATION OF INTERCHANGE FEES

Credit card schemes in Australia do not regularly apply any formal methodologies to review their interchange fees. Two approaches that could be used to determine an interchange fee were outlined in Chapter 3. The first views an interchange fee as the means by which financial institutions recover costs from those who benefit from card payment networks. Applied to credit card networks, where card issuing costs are normally well above card acquiring costs, the interchange fee is seen as a means of recovering specific issuing costs from merchants. Typically, three main costs have been included under this approach:

- *Funding cost of the interest-free period.* The argument is that merchants receive benefits, including more impulse purchases and higher spending, by allowing customers to purchase with a grace period before settling their credit card account. A monthly billing cycle and a period, say, of 15 days before settlement is due is equivalent to the provision of 30 days' interest free credit on average. Offering this facility themselves would be costly to merchants and would expose them to credit



risks and the burden of managing those risks. By providing the interest-free period, it is argued, credit card networks allow merchants to receive the benefits of this facility without incurring the direct costs.

- *Costs related to the funds guarantee.* Provided merchants follow agreed procedures, they are guaranteed payment. Issuers incur a number of costs in providing this guarantee, including the cost of fraud (and its prevention), credit losses and various risk control costs, such as authorisation of transactions and investigation of specific transactions.
- *Processing costs.* Issuers also incur costs in receiving, editing and balancing incoming purchase transactions and sending ‘chargebacks’ (a transaction which an issuer returns to an acquirer).

Using the data in Table 5.1, the simple addition of these categories gives an ‘indicative’ interchange fee that would flow from this first approach. That fee is \$0.89, slightly less than the average interchange fee of \$0.95.

**Table 5.2: Indicative interchange fee –
cost recovery basis
(\$A)**

Interest-free period	0.26
Credit losses	0.35
Fraud	0.07
Authorisation	0.04
Processing	0.17
	<hr/>
	0.89

If card schemes were to apply this methodology, two issues would need to be resolved. The first is whether each of the specific costs listed above should be included in interchange fee calculations and be passed on to merchants. The interest-free period, for example, offers benefits to both merchants and cardholders. For small merchants who have never provided credit to their customers, participation in a credit card scheme allows them to offer a credit facility. Credit card schemes also allow other merchants to substitute credit funded by financial institutions for credit they were providing themselves. Even so, large merchants in Australia typically retain their store cards, which offer a credit facility. The continued existence of store cards suggests that large merchants consider the benefits of offering their own card, particularly in generating



loyalty to the store, to outweigh any additional costs of providing credit themselves. Substituting credit provided by a financial institution which is a member of a credit card scheme for these store-based credit programs is therefore not an unambiguous benefit for these merchants.

It is also argued that the interest-free period allows cash-constrained customers to purchase when they otherwise could not. This can benefit a merchant by encouraging impulse sales and higher average transaction values. It may be true, for an individual merchant, that acceptance of a credit card increases its sales because it can attract customers from other merchants that do not accept cards. But as credit card networks become more widespread, accepting a credit card becomes a condition of doing business rather than a means of gaining an advantage over competitors. The study sought statistical evidence on the effect of credit cards on spending levels, but no evidence was forthcoming.

At the same time, an interest-free period also provides a benefit to cardholders, especially those who use the credit card purely as a payment instrument (that is, who do not use the line of credit). Card scheme members said they could not identify the proportion of credit card users in this category but casual observation suggests that it is increasing. A cardholder who uses only the payment facility and spends an average of \$575 each month on their credit card gains a benefit from the interest-free period that costs card issuers around \$29 per annum to provide, at an interest rate of 5 per cent.²⁷ In return, the cardholder pays only an annual fee averaging around \$20 for standard credit card products, which also has to cover such costs as account maintenance and statements.

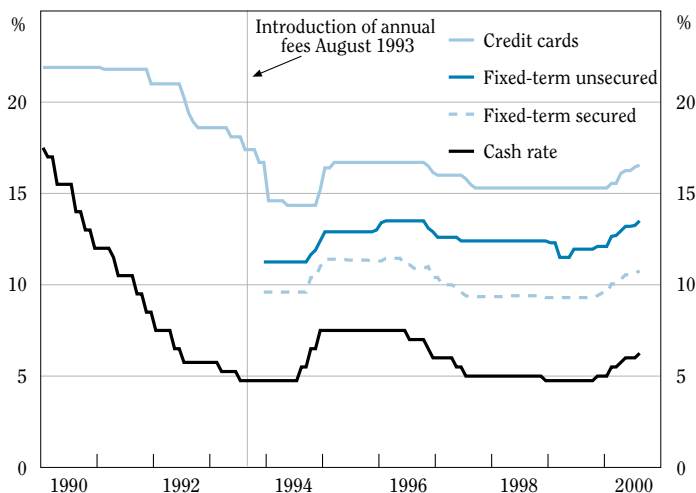
In addition, it is not clear that fraud costs incurred by issuers should be borne by all merchants. Credit cards are increasingly being used over the telephone and Internet for purchases and payment of utility bills. Such 'card not present' transactions do not usually attract a guarantee of payment because merchants are unable to verify signatures. Although payments may be authorised by the card issuer, the risk of fraud is often borne directly by the merchant, to whom fraudulent transactions may be charged back if the cardholder disputes a transaction. In many countries, credit card schemes recognise this in a lower interchange fee so that merchants do not pay twice – once for the purchases directly charged back to them, and a second time to cover issuers' fraud losses in respect of other merchants for which payments are guaranteed. In Australia, by contrast, 'card not present' transactions attract the higher interchange fee of 1.2 per cent for transactions that do not qualify as electronic. The study can see no logical basis for this practice when fraudulent transactions can be charged back to the merchant; it has some merchants paying twice.

27. Reserve Bank of Australia data show that, in the 12 months to June 2000, average monthly expenditure per credit card account was \$575. Assuming that expenditure is evenly distributed through the month and payment is made 15 days after the billing cycle, the average daily amount of interest-free credit provided to the cardholder will be \$575. The cost of providing this credit would be $\$575 \times 0.05 = \29 per annum.



The second issue to be resolved is whether costs that might be included in the interchange fee are already being recovered from cardholders. Their inclusion in interchange fee calculations in these circumstances would amount to ‘double dipping’. The inclusion of credit losses in the interchange fee is usually defended on the basis that issuers absorb these losses in providing the payment guarantee to merchants. At the same time, financial institutions argue that credit card interest rates need to be set with a sufficient premium to cover credit losses. Credit card lending is unsecured and thus riskier than some other forms of lending; nonetheless, interest rates on credit card lending are typically around three percentage points above the rates for other forms of unsecured personal lending (Figure 5.1).²⁸

Figure 5.1: Selected interest rates



Source: Reserve Bank of Australia *Bulletin*

If this interest margin is to cover average losses from credit card lending, there is no case also to include credit losses in calculations of interchange fees. The margin represents revenue per transaction of around \$0.34,²⁹ little different from the figure of \$0.35 for total credit losses in the indicative interchange fee calculations in Table 5.1.

28. There is no consistent historical series on interest rates on unsecured personal overdrafts, which are probably closest in risk characteristics to a revolving credit card loan. Survey data from CANNEX shows that the interest rate on unsecured personal overdrafts is currently around 0.2 percentage points higher than that for unsecured fixed term lending.
29. The stock of credit card debt outstanding averaged \$14 billion in 1999/2000, but a proportion of this debt includes account balances measured at the end of the month that will be paid in full and thus generate no interest revenue. Assuming that 50 per cent of credit card debt outstanding attracts interest, the three per cent margin represents revenue per transaction of \$0.34, calculated on 617 million transactions per annum.



If card schemes were to include credit card losses in interchange fee calculations, card issuers would be recovering the costs of credit losses twice.

On these arguments, application of a formal cost recovery methodology would produce an interchange fee in Australia well below current levels. The indicative calculations in Table 5.1 would need to be revised in two ways:

- the full cost of providing the interest-free period would not be passed on to merchants. In its review of UK credit card schemes, the Cruickshank report argued that this cost should be excluded completely from interchange fee calculations, on the basis that the supply of credit to cardholders is fundamentally not a payment service provided to merchants but a credit service provided to cardholders. Further, if the cost of the interest-free period were included, card issuers would be over-compensated because they would receive interchange fees for credit card payments by cardholders using the revolving credit facility, who generally do not benefit from any interest-free period. An alternative view is that merchants as well as cardholders benefit from the interest-free period and merchants should bear some proportion of this cost. In the absence of any objective criteria, a reasonable benchmark might be to include up to half the cost of the interest-free period in the interchange fee. Depending on the view taken, the amount included in the interchange fee for this cost item would therefore range from zero to \$0.13; and
- credit losses would not be passed on to merchants. The evidence suggests that cardholders using the revolving credit facility are fully covering average credit losses by paying interest rates well above rates on other unsecured personal lending.

With these adjustments, the indicative interchange fee would range between \$0.28 and \$0.41 per transaction, less than half the current average level (Table 5.3). For those

Table 5.3: Indicative interchange fee – alternative cost recovery basis (\$A)

Cost	Original	Alternative
Interest-free period	0.26	0.00-0.13
Credit losses	0.35	–
Fraud	0.07	0.07
Authorisation	0.04	0.04
Processing	0.17	0.17
	<hr/> 0.89	<hr/> 0.28-0.41



‘card not present’ transactions in which the merchant receives no guarantee of payment, the indicative interchange fee should be even lower because it should also exclude the cost of fraud, a risk that the merchant bears directly.

The second interchange methodology outlined in Chapter 3 sees an interchange fee as a redistribution mechanism that ensures issuers and acquirers will participate in the network. If acquirers can earn sufficient revenue from merchants to cover their costs and issuers can do likewise from cardholders, both acquirers and issuers will be prepared to participate. However, if either the acquirer or issuer cannot recover its costs but the other can more than do so, an interchange fee can serve as a way of redistributing revenue to make both activities profitable. This methodology focuses on total revenues and costs rather than specific cost components.

An indicative interchange fee needed to redistribute revenues under this alternative methodology can also be calculated from the data in Table 5.1. Credit card acquirers earn revenues from merchants (net of interchange fees) of \$0.72 per transaction and incur costs of \$0.43. Even allowing for a return on capital, a mark-up of this size would suggest that acquirers have adequate incentive to provide acquiring services. Credit card issuers earn revenue from cardholders of \$1.74 per transaction through the interest margin, annual fees and other sources such as late penalties. However, they incur costs of \$1.93 per transaction, leaving a shortfall of \$0.19 per transaction. The argument is that unless issuers can recover this shortfall through further charges on cardholders, they must do so indirectly from merchants, through an interchange fee, if they are to participate in the scheme. The minimum interchange fee under this approach would be \$0.19.

The status of credit card interchange fee arrangements under the *Trade Practices Act 1974* is currently unresolved. The ACCC has stated that interchange fee arrangements may, in appropriate circumstances, give rise to sufficient public benefit to justify authorisation under the Act. If some form of interchange arrangements are ultimately authorised, the analysis in this Chapter – although only indicative – suggests that the application of a formal methodology would produce interchange fees well below their current level. The figuring shown does not, of course, make explicit allowance for a return on capital. However, even if capital could be accurately allocated to credit card activities, it is not clear that issuers should seek to earn a return on capital through an interchange fee passed on to merchants. As far as the study is aware, this is not done in any of the methodologies used elsewhere by the international credit card schemes.

5.3 CARDHOLDER CHARGES AND THE ‘NO SURCHARGE’ RULE

The evidence presented to the study indicates that, of all the participants in credit card networks, cardholders who use the credit card purely as a payment instrument are contributing least to the recovery of costs. Annual fees do not cover the average cost of the interest-free period and account maintenance and statements. Furthermore, credit



card users do not face transaction fees; where loyalty points can be earned, the marginal cost of a credit card transaction to the cardholder is negative (ie they are effectively paid for using a credit card). Simple economics shows that when a service is underpriced, it tends to be over-used. The current incentives to use credit cards run the risk of pushing the credit card network beyond its optimum size, particularly given that there is an alternative low-cost payment instrument in the form of debit cards. This issue is explored further in Chapter 7.

A greater contribution by cardholders to the costs of using a credit card would provide scope to lower interchange fees, merchant service fees and prices of goods and services. The present fees charged to merchants are ultimately passed on to all consumers – not just those using credit cards – in the form of higher prices of goods and services. In effect, credit card users are being cross-subsidised by other customers. One way of ensuring that cardholders bear more of the costs is through increases in direct charges by card issuers. The possibilities include:

- an increase in the annual fee; or
- introduction of a transaction fee as applies in most other payment instruments (once they exceed their fee-free threshold) but not on charge cards, store cards or credit cards.

Higher direct charges on cardholders might be expected to lead to some contraction in credit card usage. The extent is difficult to predict, but some indication of magnitudes can be gleaned from the impact of the imposition of annual fees in late 1993. The PSA estimated that the number of credit card accounts held at major banks fell by around 8 per cent between December 1993 and mid-April 1994, around the time annual fees began to take effect.³⁰ The PSA attributed this decline to consolidation of card holdings and cancellation of under-utilised accounts. Despite a significant initial impact, however, the number of credit card accounts per capita soon began to rise again and regained their pre-fees level within three years. The number had risen a further 15 per cent by 1999.

An alternative way in which cardholders could bear more of the cost of credit cards is through a surcharge imposed by merchants on credit card users. Under present arrangements, the prices charged to customers for goods and services reflect all costs plus a profit margin. One of the costs that is embedded in prices is the cost of the payment instrument. In the case of credit cards it is the merchant service fee which averages 1.78 per cent of the value of transactions. An alternative arrangement would be one in which merchants had the discretion to charge customers the price net of the cost of the payment instrument and then add a surcharge to cover that cost. The surcharge would vary depending on the cost of the payment instrument – it would be higher for credit cards which are expensive to merchants and lower for less expensive

30. Prices Surveillance Authority (1995a).



instruments such as debit cards. This would allow customers to choose the payment instrument which provided the best combination of convenience and cheapness. However, this alternative is currently precluded by credit card scheme rules.

To accept credit card payments using MasterCard, Visa or Bankcard, merchants in Australia must enter into a merchant agreement with a financial institution that is a member of the respective credit card scheme. In MasterCard and Visa merchant agreements, a 'no surcharge' rule is a standard term – that is, merchants cannot charge a customer who wants to use that credit card more than they would for any other payment instrument.³¹ (The rule does not prohibit discounts for cash.) For Bankcard, a similar rule is optional in merchant agreements.

The operation of 'no surcharge' rules has been the subject of a number of official enquiries in Australia and overseas. All have concluded that the rules are not in the public interest.

The Trade Practices Commission (TPC), the predecessor of the ACCC, discussed the rule in its 1980 determination granting authorisation for the Bankcard scheme.³² At that time, the Bankcard rules required participating merchants to supply their goods and services to the cardholder at the merchant's normal prices. The TPC concluded that this rule was anti-competitive because it prevented merchants from adopting variable pricing techniques as a method of competing with other merchants. It also concluded that the rule did not benefit the public, although it acknowledged that the rule may benefit Bankcard members and Bankcard users. The TPC granted authorisation for the Bankcard scheme on condition that there was no agreement or understanding between scheme members that would restrict the freedom of merchants to determine the prices at which they were prepared to provide goods or services to customers paying either with cash or Bankcard.³³

In 1991, the Martin Committee report into banking and deregulation also discussed the operation of credit card scheme rules as they related to pricing by merchants. The Committee concluded that these rules were unfair and recommended that merchants accepting credit cards should be free to make their own decisions as to the prices they charge. Differential pricing by merchants should not be prevented by financial institutions.³⁴

31. There is one exception. In taxis, cardholders are asked to pay 10 per cent on top of the fare if they use one of a number of payment cards, including MasterCard and American Express. Visa cards are not accepted in taxis because Visa refuses to allow any surcharge.

32. Bankcard Scheme: Interbank Agreement (1980) ATPR (Com.), 50-100, at 52, 169.

33. The Commission's authorisation of the Bankcard scheme was revoked on 22 March 1990: Bankcard Interbank Agreement (1990) ATPR (Com.), 50-093.

34. House of Representatives Standing Committee on Finance and Public Administration (Martin Committee) *A Pocket Full of Change: Banking and Deregulation*. Canberra: AGPS, November 1991, p. 366.



The PSA discussed the issue of differential pricing in more detail in its 1992 *Inquiry into Credit Card Interest Rates*.³⁵ At that time, State Credit Acts were seen as obstacles to the introduction of differential pricing. The PSA concluded that, while many retailers might not take up the option, an ‘in principle’ case existed – in the interests of efficient pricing – to give merchants the freedom to set prices that reflect the costs involved in effecting transactions, including the costs associated with different methods of payment. The PSA recommended that the restrictions in the State Credit Acts that prevented or discouraged differential pricing should be revoked.

Following this report, Australia’s credit laws were amended to remove the legislative obstacles to differential pricing. Despite this, the ability of merchants to adopt more flexible pricing strategies continues to be restricted by the ‘no surcharge’ rules imposed on them as a condition of their participation in credit card schemes.

Criticism of ‘no surcharge’ rules has not been limited to Australia. A 1989 report by the U.K. Monopolies and Mergers Commission on credit card services concluded that this rule operated against the public interest because it restricted the freedom of retailers to set their own prices.³⁶ In the United States, there has been a longstanding debate about differential pricing since the *Truth in Lending Act* was amended in the 1970s to enable cash discounts.³⁷

‘No surcharge’ rules have an important impact on price signals. To the extent that credit card payments are more costly for merchants than some other payment instruments, displacement of these instruments by credit cards raises merchant costs. These costs are ultimately passed on to all consumers in the form of higher prices, giving rise to the cross-subsidisation of credit card users mentioned above.

As with higher direct charges, the passing of some or all of the merchant service fee on to cardholders through a merchant surcharge might be expected to result in a contraction in credit card use. The extent depends largely on the maturity and ubiquity of the credit card schemes. In the early stages of credit card networks, consumers may well have responded to merchant surcharges by not taking up and using credit cards; at that time, consumers may have needed incentives to test the benefits of using these networks. However, the credit card networks in Australia are now mature systems. Credit cards are second only to cheques as a payment instrument and the number of credit card payments has doubled over the past four years. Unlike a new instrument, consumers are comfortable using credit cards and well aware of their benefits and

35. Prices Surveillance Authority (1992).

36. Monopolies and Mergers Commission, *Credit Card Services: A report on the supply of credit card services in the United Kingdom*. London: HMSO, 1989. The Monopolies and Mergers Commission was replaced by the Competition Commission on 1 April 1999.

37. For an historical survey of the debate in the United States, see Kitch (1990).



convenience. Merchant acceptance has also grown. Credit cards are being used for new classes of payments, such as grocery purchases and utility bills, and they have become a predominant form of payment over the phone and Internet. These developments suggest that credit card networks would face adjustments only at the margin if cardholders bore more of the costs involved.

Even if credit card usage were to contract, it does not follow that there would be an overall loss of network benefits to society, particularly if current incentives for card users are encouraging over-use of credit cards. Economic analysis is ambiguous on whether society would be worse off with a merchant surcharge when there is a low-cost alternative payment instrument such as debit cards. The onus is on proponents of 'no surcharge' rules to explain how society might lose if credit cardholders respond to merchant surcharges by switching to debit cards.

The study's view is that 'no surcharge' rules suppress price signals that guide the efficient allocation of resources. They result in cross-subsidisation of cardholders by consumers who do not use credit cards; they restrict competition between merchants by limiting the range of pricing strategies they can use; and they prevent end-users exerting competitive pressures on merchant service fees and interchange fees. On balance, the study concludes that 'no surcharge' rules are not desirable. Merchants should not be prevented by the credit card schemes from passing on some or all of the merchant service fee through surcharges, even if some merchants do not avail of the flexibility for their own commercial reasons.

The operations of charge cards are outside the scope of this study and there are no interchange fees to be passed on through the merchant service fees these schemes apply. Nevertheless, the arguments against any 'no surcharge' rules in these schemes would also apply.

5.4 ACCESS TO CREDIT CARD SCHEMES

The information provided to the study shows that the provision of credit card services in Australia generates revenues well above average costs, particularly for financial institutions which are both significant card issuers and acquirers. In a competitive market, it would be expected that competition from new entrants would put downward pressure on these margins and on interchange fees.

Conditions of access are critical in determining the degree of potential competition in a market. High barriers to entry are likely to entrench the market power of incumbents; on the other hand, if entry barriers are low, competition can be effective even if the market is quite concentrated. The Financial System Inquiry highlighted restrictions on participation in credit card schemes as an area of concern. The concern was that card scheme rules might be used to restrict the ability of non-deposit-taking institutions to compete in new payment technologies. Accordingly, the Inquiry recommended that



the ACCC maintain a watching brief over credit card rules and membership arrangements of card schemes.

This study has focussed on two key dimensions of access to credit card schemes:

- the criteria for participation in the schemes; and
- the price of entry.³⁸

The major criterion for participation in credit card schemes is that card *issuers* must be authorised deposit-taking institutions. In the case of MasterCard and Visa, this requirement is formalised in the regulations. In the case of Bankcard, there is no such explicit restriction but new members must have the unanimous approval of the four remaining founding banks (Australia and New Zealand Banking Group, Commonwealth Bank of Australia, National Australia Bank and Westpac Banking Corporation).

The study recognises that there are good reasons why card issuers should have financial standing. Credit card networks can only operate if all cards are accepted. Under the 'honour all cards' rule, merchants signing up to MasterCard, for example, must accept all MasterCard credit cards; they cannot refuse to accept a MasterCard because the card is issued by a bank they have not heard of. The same rule applies for Visa. The MasterCard and Visa networks are built around arrangements that ensure the merchant will be paid even if the institution that issued the card cannot meet its obligations. In order to satisfy this guarantee, the members of MasterCard and Visa will meet the obligations of any issuer that cannot settle. In these circumstances, established members need to be assured that any new members do not impose significant settlement risks on the system. The schemes achieve this by restricting issuing to supervised financial institutions.

In the study's view, some form of restrictions on issuing can be justified if their aim is to ensure that issuers are financially sound, able to meet their obligations and will not disrupt the credit card system. Since they are not taking deposits, such issuers need not be authorised deposit-takers, but the requirement of authorisation and on-going prudential supervision has been a long-established and effective screening device.

Such a rule is not, however, the only way of establishing the financial soundness of a firm. Participation criteria based on institutional status may create higher entry barriers than justified to ensure the security and integrity of the card schemes. Non-financial institutions as well managed as many financial institutions might, at some point, wish to issue general-purpose credit cards. A broader set of criteria would be needed to assess the qualifications of such institutions, but this would not be difficult to devise. The introduction of such criteria would present non-traditional firms with the opportunity to compete and innovate in these established schemes and, potentially, in the provision of newer payment instruments.

38. The study has not undertaken a detailed analysis of the technical and procedural rules of the MasterCard, Visa and Bankcard schemes.



More objectionable, from the study's point of view, is the requirement in both the MasterCard and Visa rules that *acquirers* must also be issuers. Combined with the restrictions on issuing, this limits acquiring to authorised deposit-taking institutions. The study sees no justification for such a restriction. Acquirers pay their merchants and receive funds from issuers; as net receivers of funds, they do not introduce settlement risk for other financial institutions in the system. They need to be able to process transactions for their merchants in an efficient, reliable manner. They also have to bear the risk of merchant fraud and may face substantial costs if a merchant collapsed with goods paid for by cardholders but not delivered. Acquirers need sufficient skills and substance to be able to assess and cover such risks when signing up merchants. None of these functions, however, requires the acquirer to be an authorised deposit-taking institution. Merchants would have to hold their deposits with an authorised deposit-taker, but this need not be the acquirer.

In its review of the UK credit card schemes, the Cruickshank report also concluded that restrictions on which organisations can be acquirers were not justified. It addressed three arguments for the restrictions: that acquirers which did not also issue cards would face a conflict of interest and have no commitment to the maintenance of the scheme; that the restrictions ensure balanced development of the scheme; and that it would not be fair on issuers which are also acquirers if non-issuers were allowed to compete for acquiring business. The Cruickshank report found none of these arguments convincing.

In addition to the evidence of wide margins of revenues over average costs in credit card acquiring, doubts about the degree of competition in the acquiring business in Australia are raised by the structure of the merchant service fee. As noted earlier, this fee – which covers the interchange fee and acquirers' costs – is typically charged on an ad valorem basis. However, credit card acquiring is a volume-based business³⁹ and a flat fee for acquiring services would be more in line with the costs incurred. Competitive pressures have not led to a more appropriate two-part charging structure for merchants, involving an ad valorem component for the pass-through of the interchange fee and a flat fee on top. One reason may be that a single ad valorem fee has been easier to administer. However, it may also be the case that merchants are not well-informed about the services they are receiving for the merchant service fee, or have not been offered a choice of fee structures.

The study is particularly concerned about the lack of transparency and objectivity in the Bankcard membership procedures, where membership applications are determined at the sole discretion of the four founding banks. This restrictive approach to

39. The costs of merchant fraud are the only exception but they make a relatively small contribution to total acquiring costs.



membership was one of the reasons why the TPC revoked its initial authorisation of the Bankcard scheme. In its decision, the TPC noted in particular that Bankcard had refused membership to a number of banks, including the Bank of Singapore and Citibank.⁴⁰ Bankcard's membership procedures appear to have operated to ensure that the field of competition for the issuing of Bankcards and the acquiring of Bankcard transactions remains tightly restricted to a small number of banks.

The study also examined whether membership fees of the credit card schemes might be a barrier to entry. The MasterCard and Visa fees are relatively low and do not appear to act as a deterrent. Membership fees for Bankcard are much higher and are of concern. The study heard objections from some smaller players that the cost of membership of Bankcard was preventing them from competing in the acquiring market, since they could not offer a full acquiring service. Merchants want their acquirer to be able to accept all cards. Institutions that are not members of Bankcard are unable to acquire Bankcard transactions and are therefore unable to compete effectively in the acquiring market for both credit and debit card transactions.

In summary, restrictions on access have been an important influence on credit card interchange fees in Australia. The largest credit card issuers are also the largest acquirers, and card scheme rules prevent non-deposit-taking institutions from competing in issuing and acquiring activities. As a consequence, financial institutions which are card scheme members are under little pressure to lower interchange fees – as issuers they receive revenue from these fees and as acquirers they can pass the fees on to merchants. Merchants, in turn, have little scope to resist since they do not have the option of shopping around for an acquirer seeking to recover a lower interchange fee; their only option is the extreme one of refusing to accept credit cards. And because of 'no surcharge' rules, credit cardholders face no direct price signals that would lead them to resist higher interchange fees.

CONCLUSIONS

- *Credit card issuing in Australia generates revenue well above the average cost of providing these services. The margin between revenues and average cost, on a percentage basis, is wider for credit card acquiring. Only part of these margins appears to be attributable to the need to earn a competitive return on capital.*
- *Interchange fees account for around one-third of revenue from credit card issuing. The major contribution to revenue comes from cardholders who make use of the line of credit.*

40. See Bankcard Interbank Agreement (1990) ATPR (Com.), 50-093. At the time Citibank's application was refused, its parent company was the largest issuer of bank credit cards in the world.



-
- *Interchange fees are not reviewed regularly by the card schemes on the basis of any formal methodology. Application of a formal cost-based methodology would suggest an interchange fee well below current levels.*
 - *'Card not present' transactions, where merchants are unable to verify signatures, do not usually attract a guarantee of payment for merchants. Even so, such transactions are charged at the higher interchange fee of 1.2 per cent for transactions that do not qualify as electronic. The study can see no logical basis for this practice.*
 - *Cardholders who use credit cards purely as a payment instrument contribute least to the cost of credit card schemes and, in some cases, are effectively paid to use credit cards. A greater contribution from such cardholders would reduce the subsidy they receive from other consumers.*
 - *The study can see no convincing reason for the 'no surcharge' rule preventing merchants passing on their costs for accepting credit cards.*
 - *Current restrictions by card schemes on which institutions can enter the acquiring business are unjustified. Restrictions on access to card issuing may also be overly limiting and need to be reviewed.*



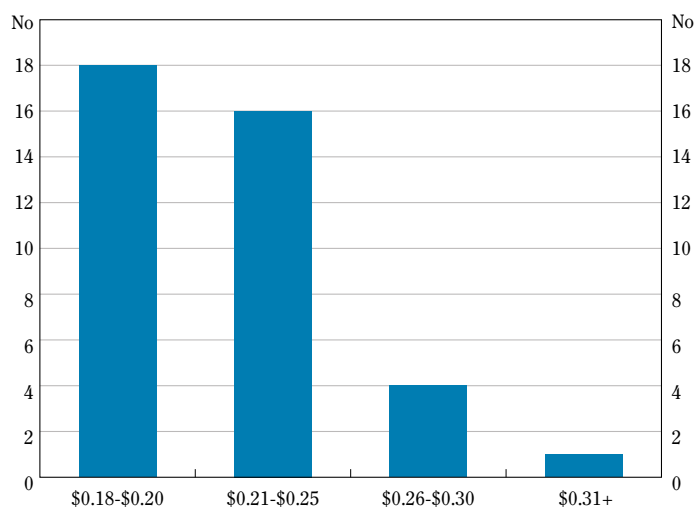


6. DEBIT CARD NETWORKS

6.1 FEES AND COSTS

In Australia, when a cardholder uses a debit card to make a purchase from a merchant, the card issuer pays an interchange fee to the merchant's financial institution (the acquirer). These interchange fees are negotiated bilaterally between card issuers and acquirers and are a flat amount rather than a percentage of the value of the transaction. There were 39 bilateral interchange agreements reported to the study, of which 34 have interchange fees falling within a range of \$0.18 to \$0.25 (Figure 6.1). These agreements are typically 'knock-for-knock' – the fee is the same regardless of which of the two parties to the agreement is the issuer or the acquirer.

Figure 6.1: Interchange fees for debit card transactions
Number of agreements

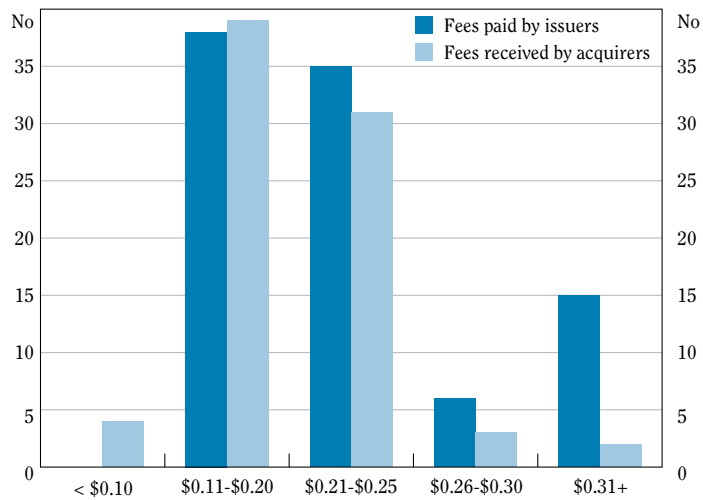


However, many financial institutions do not have bilateral agreements with every issuer and/or acquirer. If these institutions wish to participate in the debit card network, they must use a 'gateway', which allows them access through the bilateral links already established by the gateway institution. Gateway arrangements mean that there are many more participants in the debit card network than the number of bilateral agreements would suggest.



The use of gateways also means that the fees paid by issuers and received by acquirers may not reflect interchange fees alone. Issuers using gateways have to pay the gateway fee, between \$0.10 and \$0.15, on top of the interchange fee that the gateway institution pays the acquirer. As a consequence, there are 21 issuers that pay fees of more than \$0.25 per transaction. Acquirers operating through a gateway have the gateway fee deducted from the interchange fee that the issuer pays the gateway institution. As a consequence, there are four acquirers that receive fees of less than \$0.10 per transaction. The dispersion of fees paid by issuers and received by acquirers for debit card transactions, after taking into account the effects of gateway fees, is shown in Figure 6.2.

**Figure 6.2: Fees for debit card transactions
(taking into account gateway fees)**
Number of agreements



In 1999, the amount of interchange fees paid to debit card acquirers in Australia was in the order of \$100 million.

Interchange fees for debit card transactions have hardly changed since they were introduced in the early 1990s. Newer agreements appear to have been based on earlier agreements, without regard for changes in costs that may have warranted a revision to interchange fees.



Merchants negotiate fees for accepting debit card transactions directly with their financial institutions. There are two distinct merchant segments in the Australian debit card network:

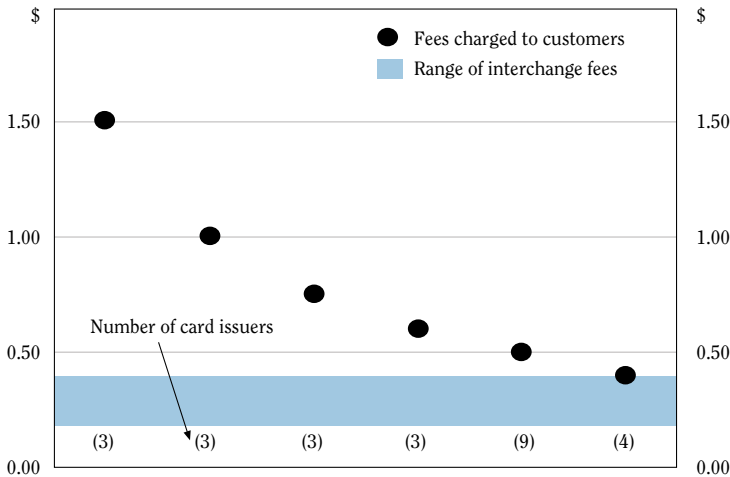
- smaller merchants buy the full range of acquiring services (terminals, switching, provision of funds, etc) from their financial institution and pay a merchant service fee. Although the study did not collect specific data on merchant fees, an average merchant service fee of \$0.80 per transaction can be inferred from the information provided on merchant revenue and debit card volumes. The fee is normally flat but in some cases may be a percentage of the value of the transaction;
- in contrast, most large merchants take on some of the capturing, transmission and processing of debit card transactions using their own facilities, and many have negotiated arrangements under which they share the interchange fee with their financial institution. For the financial institution, the amount of interchange fee revenue it shares with such merchants reduces the total revenue it receives from merchants.

The involvement of large merchants in acquiring activities dates from the early days of the debit card payment network, when many decided that it was in their interest to own and operate their debit card infrastructure. They saw advantages from integrating the payment infrastructure with cash registers and stock control systems, as well as from reduced dependence on financial institutions. Large merchants with their own acquiring infrastructure account for the majority of debit card payments accepted, in terms of both numbers and value. As a result of their investment in debit card infrastructure, and their market size, these merchants have had sufficient bargaining power with their acquirers to be able to share part of the interchange fee received from issuers.

Unlike ATM transactions, where card issuers pass interchange fees for every transaction onto their cardholders through foreign ATM fees, cardholders using their debit card for payments can normally avail themselves of a number of fee-free transactions each month on their transaction accounts. Beyond their fee-free limit, cardholders pay a transaction fee for debit card payments. Figure 6.3 shows these transaction fees for a sample of financial institutions compared to the range of interchange fees for the industry. In nearly all cases the transaction fee is above the maximum interchange fee, in some cases substantially so. The extent to which card issuers recoup interchange fees from cardholders will therefore depend on the number of fee-free transactions their cardholders make each month, and on the gap between interchange fees and transaction fees.



Figure 6.3: Customer fees for debit card transactions
(after fee-free transactions)



Source: CANNEX Australia and information provided to the study

Data on debit card costs and revenues for 1999 were supplied to the study by a group of eight financial institutions, including the four major banks;⁴¹ together, this group accounts for around 80 per cent of debit card transactions by issuer and 99 per cent of transactions by acquirer. The data are summarised in Table 6.1.

The data are subject to some caveats. On the *acquiring* side, many of the costs included in Table 6.1 are common to the acquiring of debit card transactions and electronic credit card transactions, and most institutions treat acquiring of these two types of transactions as one business. Where possible, costs specific to debit card acquiring have been identified; common costs have been allocated between debit and credit card transactions on the basis of transactions volume. On the *issuing* side, many institutions found it difficult to isolate costs attributable to debit card transactions from other costs associated with transaction accounts. This may be one reason for the wide range of costs in categories such as staff, authorisation and processing. In addition:

- some institutions could not separate authorisation costs from processing costs; these institutions tended to report higher processing costs but no authorisation costs;
- where institutions did report authorisation costs, there is quite a significant variation. The study could not identify an obvious reason for this;

41. The group did not include many of the smaller institutions that use gateways in order to participate as acquirers and issuers in the debit card payment system.



Table 6.1: Debit card costs and revenues per transaction*
(\$A)

	Acquiring			Issuing	
	Range	Weighted average		Range	Weighted average
COSTS					
Operating expenses	0.03-0.30	0.08			
Of which					
• Staff	0.00-0.23	0.04	• Production/distribution of cards	0.01-0.09	0.06
• Data processing	0.00-0.09	0.01	• Authorisation	0.01-0.13	0.03
• Switching services	0.01-0.07	0.03	• Processing	0.01-0.06	0.03
			• Staff	0.00-0.09	0.01
Overheads	0.10-0.37	0.18	• Fraud	0.00-0.01	0.01
Of which			• Other	0.00-0.05	0.02
• Depreciation	0.03-0.20	0.06	Cost per transaction	0.07-0.31	0.15
• Telecom-munications	0.03-0.13	0.05			
• Other	0.00-0.19	0.07	Interchange fees paid	0.19-0.25	0.21
Cost per transaction	0.19-0.66	0.26			
REVENUES					
Interchange fees	0.11-0.26	0.20	Transaction fees	0.15-0.25	0.20
Merchant service fees	0.01-0.52	0.12			

* Because of the weighting process, the components of average costs do not necessarily add to the total. Adding the maxima for each component may also give a figure that is higher than the maximum total cost shown because the maximum in each component is accounted for by different institutions.

- the difference in the range of interchange fees received by acquirers and paid by issuers is due to gateway fees which, if gateways are used, reduce the fees earned by acquirers and increase the fees paid by issuers;
- transaction fees earned by issuers are weighted average fees per transaction, which take into account the fee-free transactions offered by most institutions; and



- revenues earned by acquirers from merchant service fees average around \$0.12 per transaction. This is the net effect of fees from smaller merchants, and the sharing of interchange fees with large merchants that have their own acquiring infrastructure.

The evidence suggests that debit card *acquiring* generates revenues above costs, but the margin is well below that in credit card acquiring. Costs average \$0.26 per transaction and total revenues, from both interchange fees and merchant service fees, average \$0.32 per transaction. This is a mark-up over costs of \$0.06 or 23 per cent. The lower cost of acquiring debit card transactions compared to credit card transactions (\$0.43) appears to be due to the more complex electronic messages required for credit card transactions and to the continued existence of paper-based credit card transactions that are more expensive for acquirers to process than electronic transactions.

In the case of debit card *issuing*, interchange fees paid are largely covered by revenues from transaction fees on cardholders who use their debit cards beyond their fee-free limit each month. The average cost of \$0.15 per transaction is recovered as part of the overall cost of providing a transaction account, through account maintenance fees and payment of below-market rates of interest on balances. The average issuing cost per transaction is substantially lower than that for credit card transactions (\$1.93); most of the major costs incurred by credit card issuers (eg credit losses and the interest-free period) do not arise in debit card networks.

The margins between revenues and costs have not incorporated a return on the capital committed to debit card issuing and acquiring. As far as debit card issuing is concerned, a major difficulty in determining a return on capital is separating debit card services from the broader account relationship. Collecting information on the broad range of costs and revenues associated with the provision of transaction accounts was outside the scope of this study. The operational aspects of debit card acquiring are very similar to credit card acquiring, which was discussed in Chapter 5. On the same analysis, preliminary figuring would suggest that a margin over costs of only a few cents per transaction would provide a competitive rate of return for debit card acquiring.

6.2 THE RATIONALE FOR AN INTERCHANGE FEE

The direction of debit card interchange fee payments in Australia is unique. In other countries the payment is to the card issuer, or there are no interchange fees at all. None of the participants in the Australian debit card network could provide a formal methodology or empirical evidence to support either the existing direction and level of interchange fees, or a change in these arrangements.

The two alternative methodologies for determining an interchange fee, outlined in Chapter 3, could in principle be applied to debit card networks. The first approach sees an interchange fee as the means by which financial institutions recover costs from



those who benefit from card payment networks. Application of this methodology to debit cards requires judgment about who are the beneficiaries of the debit card network and the costs they should bear. If the merchant is viewed as the main beneficiary, and the interchange fee is a means of recovering specific costs from merchants, the interchange fee would include the costs related to the funds guarantee and processing costs. This approach would suggest the payment of a small interchange fee of \$0.07 to the issuer (Table 6.2). The fee would be much lower than the indicative interchange fee for credit cards under this approach because there is no interest-free period and no credit losses, fraud is very small and processing and authorisation are electronic. Furthermore, since most of the issuing costs are unrelated to the value of the transaction, the interchange fee would be flat rather than ad valorem.

From the cardholder's viewpoint, the capture and transmission of a debit card transaction by the acquirer provides a benefit by allowing the cardholder access at the checkout to their transaction account. On this argument, an acquirer would be entitled to recover specific costs from cardholders through an interchange fee paid by the issuer, and passed on to the cardholder. As Table 6.2 shows, acquiring costs for switching, depreciation, telecommunications and data processing – costs associated with access to a transaction account – average \$0.15 per transaction. Inclusion of these costs only in interchange calculations would suggest the payment of an interchange fee of \$0.15 per transaction to the acquirer (Table 6.2). If services to the merchant by the issuer were also taken into account, the payment would be \$0.08 per transaction to the acquirer (\$0.15 to the acquirer netted against \$0.07 to the issuer). Either way, since acquiring costs are largely unrelated to the value of the transaction, the interchange fee would be flat rather than ad valorem.

Table 6.2: Indicative interchange fee – cost recovery basis (\$A)

Acquirer		Issuer	
Data processing	0.01	Interest-free period	—
Switching	0.03	Credit losses	—
Depreciation	0.06	Fraud	0.01
Telecommunications	0.05	Processing and authorisation	0.06
	<hr/>		<hr/>
	0.15		0.07



There is no simple answer; in networks, all participants benefit from greater participation. The important point is that, depending on the assumptions made, this interchange methodology could be used to support payment of an interchange fee in either direction.

The alternative interchange methodology outlined in Chapter 3 sees an interchange fee as a balancing item that ensures a card network operates in the interests of all participants. Application of this methodology to debit card networks also produces an ambiguous result. Excluding interchange fees received, acquirers average \$0.12 per transaction in revenues but incur average costs of \$0.26 per transaction. The methodology suggests that they need to receive an interchange fee of at least \$0.14 per transaction to break-even and participate in the network. The data in Table 6.1, however, would suggest that issuers cannot pay that much and still find it profitable to continue to issue; their average revenues (\$0.20) exceed their costs (\$0.15) by only \$0.05, less than the \$0.14 which the methodology suggests they need to pay to acquirers.

Notwithstanding what the formal interchange methodologies might suggest, debit card issuers in Australia have been prepared to pay as much as \$0.35 per transaction (if they use gateways) to participate in the debit card network. This is because issuing of debit cards is regarded as an integral part of the provision of a transaction account, the costs of which can be recovered in various ways.

6.3 AN ALTERNATIVE TO CURRENT ARRANGEMENTS

The study has not found a convincing case for an interchange fee in the debit card network in Australia, in either direction.

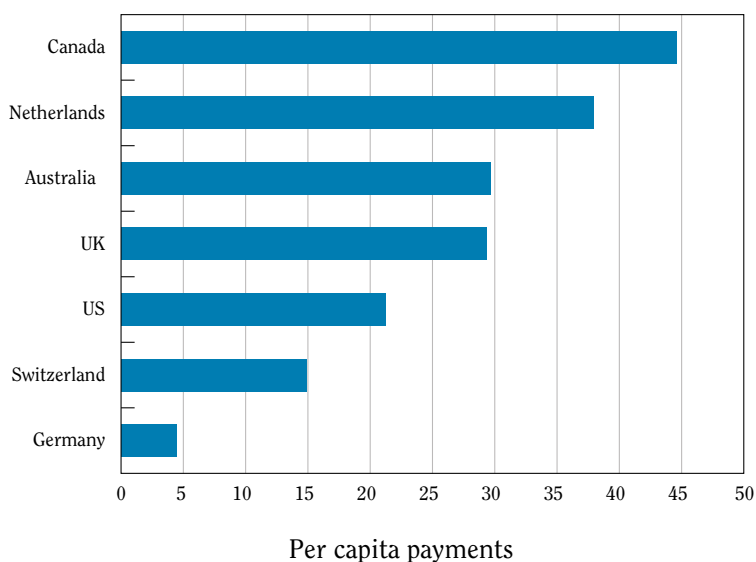
A debit card is simply a method of accessing a transaction account. It is an alternative to cheques, direct debits and direct credits which are other methods of accessing the same funds. Many of the costs of a debit card payment are associated with the transaction account itself and will be incurred by the financial institution regardless of the payment instrument used. None of these other payment instruments has an interchange fee. Each financial institution recovers its costs from its own customers: consumers pay for the provision of payment services, increasingly through a direct charge, while merchants pay a fee for services associated with accepting and processing these payments. To the extent that merchants perform some processing themselves, these fees are reduced.

The absence of interchange fee revenues to issuers has not constrained the issuance of debit cards and their use at point-of-sale in Australia. On the contrary, the use of debit cards has grown strongly. The debit cards on which the network is based had been issued by financial institutions to allow their customers access to ATMs; there has been no need to provide further incentives for their issue.



Debit cards are also well utilised at point-of-sale in other countries, despite different interchange fee regimes. Figure 6.4 shows debit card payments per capita in 1998 for a number of countries. Usage is highest in two countries with no interchange fees, Canada and the Netherlands, both of which have on-line debit card payment systems with PIN authorisation like Australia. Australian usage is on a par with the United Kingdom, where the system is usually off-line and an interchange fee flows to the issuer.

**Figure 6.4: Number of debit card payments
Per capita, 1998**



Source: Bank for International Settlements (2000)

One explanation for this mixed pattern is that different fee regimes are appropriate for different systems, such as on-line or off-line systems. An alternative interpretation is that interchange fees were not an important factor in the development of debit card systems. Both explanations are probably relevant. Off-line, signature-based systems like those in the United Kingdom typically result in higher fraud and credit losses borne by the issuer, so a payment from the merchant (who benefits from the payment guarantee) to the issuer may have been needed to encourage the growth of the system. In an on-line system such as Australia, however, these particular costs are very small and recompense to the issuer is not essential for the viability of the system.

In summary, the study believes that the debit card network in Australia does not need an interchange fee. The study sees no compelling reason why the viability of the network would be threatened if, as with other payment instruments which access a transaction



account, each financial institution were to recover its debit card costs from its own customers.

Removal of the interchange fee would have implications for one card product – the Visa branded debit card. This card, which is issued in Australia by some financial institutions, allows the cardholder to choose to press a ‘debit’ button and use a PIN, or a ‘credit’ button and sign for the transaction. In practice, these cards are simply debit cards; whichever button is selected, the funds are drawn from the customer’s deposit account.⁴² However, the interchange fee flow is quite different. If the debit button is selected, the issuer pays a flat interchange fee to the acquirer according to their bilateral interchange agreement for debit cards. If the credit button is selected, the acquirer pays the issuer the much higher, ad valorem interchange fee set for credit cards by Visa scheme members.

Not surprisingly, institutions that issue such cards encourage their cardholders to select the credit button. However, there is no case for simply extending credit card interchange fees to debit card transactions; the economics underlying these two payment networks are very different. By encouraging customers to select the credit button, issuing institutions are being over-compensated for what is, to all intents, a debit card transaction.

6.4 ACCESS TO THE DEBIT CARD NETWORK

The debit card network in Australia needs to be national if it is to offer significant benefits to cardholders who do not want a debit card that can only be used at certain merchants. And because the major retailers in Australia are national, even regional financial institutions need to provide their customers with debit cards which can be used throughout Australia.

The importance of national coverage, and the need to negotiate bilateral agreements for access, may provide established players with market power and make entry more expensive. For example, if a small issuer is unable to negotiate a bilateral arrangement with every acquirer it will need to use more expensive gateway arrangements to provide its customers with a debit card which has universal acceptance. This can give large acquirers power to charge interchange fees above cost and can raise the cost of access for new entrants. The large acquirers are also issuers and in competition with those institutions seeking to establish interchange arrangements.

The counter to this argument is that merchants want to accept all cards, no matter how small the customer base. If an acquirer cannot provide universal acceptance, the merchant will find another acquirer which can. Acquirers will therefore want to ensure that they can accept all cards. In the view of the study, however, this does not provide

42. The customer may have a pre-approved line of credit in association with the account but this is a separate decision and separately priced.



enough balance to the market power of large acquirers. The acquiring market is very concentrated, with the largest four acquirers accounting for over 90 per cent of debit card transactions; this largely mirrors concentration in the retail sector, where two national firms account for around 50 per cent of all debit card transactions.

In these circumstances, relatively small issuers – particularly new entrants – are at a disadvantage and cannot afford prolonged negotiations. The evidence on fees indicates that smaller issuers and newer entrants tend to face higher fees for debit card transactions than the larger issuers. In some cases, this is because the issuers are paying gateway fees; in other cases it reflects higher negotiated interchange fees. There are 21 instances in which issuers pay more than \$0.25 per transaction; none of these involves a major bank.

Relatively small acquirers may also be at a competitive disadvantage. Issuers (who are also typically acquirers) may decline to enter an agreement with a new acquirer, forcing the new entrant to use a gateway and pay gateway fees if it wants to pursue acquiring. This makes the acquiring business more expensive for these entrants.

Restrictions on access to credit card acquiring also have implications for access to debit card acquiring. As noted in Chapter 5, formal restrictions in credit card scheme rules on which institutions can be acquirers and, in particular, the membership fees for Bankcard, make it difficult for some institutions to enter credit card acquiring. This, in turn, restricts their ability to compete in debit card acquiring since they cannot provide a full acquiring service to merchants.

CONCLUSIONS

- *Debit card acquiring in Australia generates revenues above the average cost of providing these services but the margin, on a percentage basis, is well below that in credit card acquiring. For debit card issuing, the average cost is recovered as part of the overall cost of providing a transaction account.*
- *Debit card interchange arrangements in Australia, in which an interchange fee is paid by card issuers to acquirers, are unique.*
- *Large merchants which have invested in their own acquiring infrastructure have been able to negotiate a sharing of the interchange fee with their financial institutions.*
- *Application of formal interchange methodologies does not provide a convincing case for a debit card interchange fee, in either direction. The study does not see a continued need for an interchange fee in the debit card network.*
- *Access to the debit card network through a series of bilateral agreements can put both new issuers and acquirers at a competitive disadvantage, because they may need to use more expensive gateway arrangements.*





7. FINDINGS AND CONCLUSIONS

7.1 MAIN FINDINGS

In Australia, interchange fees are a unique feature of card payment networks. Financial institutions do not agree and pay fees between themselves when their customers use cheques, direct debits or direct credits for making payments; customers pay fees and charges for these payment instruments which are intended to cover costs and produce a return on capital.

The rationale for interchange fees is that they encourage a payment network to grow beyond a size it would attain if the financial institutions involved earned revenues solely from direct charges on their customers. Without interchange fees, direct charges might have to be set in the formative stages of a payment network at a level which discourages participation, and therefore fails to signal the network's overall benefits to society. In these circumstances, an interchange fee which overrides the usual price mechanisms and redistributes revenues between participants may be one means of expanding the network and realising network benefits.

Though it provides this broad rationale, economic analysis does not indicate the direction an interchange fee should flow or how it should be calculated. More importantly, it provides only very general principles for determining the optimal level of interchange fees. These are issues to be addressed within the circumstances of individual payment networks. Nonetheless, there are two broad tests which any interchange fee regime should be expected to meet if it is to contribute to efficient resource allocation. Interchange fees should:

- not overcompensate financial institutions for the costs that they incur; and
- be subject to regular review as costs and other conditions in the relevant payment network change.

This study has reviewed the role of interchange fees in the ATM, credit card and debit card payment networks in Australia, based on cost and revenue data from financial institutions which provide the bulk of card services. Its main findings are that:

- I Interchange fees for ATM services are around double the average cost of providing these services and these fees are passed on, fully or more than fully, to cardholders who use the ATMs of other financial institutions. Such cardholders generate a stream of net revenue for financial institutions.
- II Credit card interchange fees are significantly above levels suggested by cost-based methodologies and contribute to margins of revenues over average costs of around 39 per cent for card issuers. Margins over average costs earned by acquirers are around 67 per cent. Interchange fees have not been regularly reviewed by the card schemes using any formal methodology.



-
- III In 'card not present' transactions, where merchants are unable to verify signatures, credit card issuers do not usually guarantee payments to merchants. Even so, such transactions are charged at the higher interchange fee of 1.2 per cent for transactions that do not qualify as electronic but attract a payment guarantee. There is no logical basis for this practice.
 - IV 'No surcharge' rules in credit card schemes prevent purchasers from confronting the cost of this payment instrument vis-à-vis lower cost payment instruments such as debit cards. It means that other consumers subsidise credit cardholders and financial institutions which are card scheme members. An alternative arrangement would have merchants exercising discretion to charge customers prices that are net of the cost of the payment instrument, and add a surcharge to cover that cost.
 - V Competition in credit card issuing and acquiring is limited by restrictions on access to credit card schemes. Excluding all institutions other than authorised deposit-takers from access to acquiring, in particular, is difficult to justify on risk grounds.
 - VI Interchange fees for debit card payments contribute to margins over costs of around 23 per cent for acquirers, much lower than in credit card acquiring. Formal interchange methodologies do not provide clear support for an interchange fee for debit card payments, in either direction.

In summary, current interchange fee arrangements in Australia could not be said to meet the two broad tests above. First, interchange fees in all three card networks provide, or contribute to, revenues above the average costs of the relevant card services, particularly in the ATM and credit card networks. Although financial institutions were generally unable to supply data in this area, preliminary figuring by the study suggests that these margins are not needed by financial institutions to earn their required return on capital. Secondly, in all three card networks, interchange fees have been very sticky over long periods. They have not been regularly reviewed despite significant changes in underlying costs over recent years.

7.2 ANALYSIS OF COMPETITION AND ACCESS

Interchange fees are set by card issuers and acquirers at 'one step removed' from the cardholders and merchants who ultimately bear these fees through transaction charges or through the general cost of goods and services. Users therefore do not have a direct influence on the pricing of card payment services but must rely on their financial institutions to represent their interests. As a consequence, the price signals and competitive responses that would be expected to put pressure on margins in card payment networks have not worked effectively. These difficulties are reinforced by restrictions on access to the card networks, both explicit and informal, and by the 'no surcharge' rules in credit card schemes.



The limitations on competition are apparent in each of the three payment networks examined in this study, though they occur in different ways.

In ATM networks, most interchange fees were negotiated between card issuers and ATM owners over a decade ago and few have changed since that time. A distinguishing feature of ATM networks in Australia is that the largest ATM owners are also the largest issuers. As owners, they have little incentive to lower interchange fees because these fees ensure a significant contribution to revenues from customers of other financial institutions. As issuers, they can pass interchange fees onto their cardholders in the form of foreign ATM fees, claiming that the interchange fees have been imposed on them and reminding their cardholders that they have the option of using their own network. New entrants, which tend to be relatively small institutions, have little bargaining power and are price-takers in interchange fee negotiations. In short, there are few competitive pressures or incentives to bring ATM interchange fees into line with costs.

Interchange fee arrangements are the predominant means by which ATM owners in many countries recoup the costs of providing ATM services to cardholders of other financial institutions, but they are not essential to ATM networks. An alternative is a direct charging regime, which would establish an economic relationship between the user and the provider of ATM services and allow users to exert a direct influence on pricing.

In credit card schemes, interchange fees are agreed jointly by the financial institutions which are members of the card schemes. Again, the largest issuers are also the largest acquirers. As issuers, they benefit from interchange fee revenue, which reduces their need to recover costs from their own cardholders. Neither issuers nor their cardholders have an interest in lower interchange fees. As acquirers, they pass the jointly agreed interchange fee, as well as their acquiring costs, onto merchants. Merchants can only avoid the interchange fee by refusing to accept credit cards – not a viable option in most businesses. ‘No surcharge’ rules, in turn, prevent merchants passing on the cost of credit card services only to those customers that benefit from them. As a consequence, cardholders face price signals which do not reflect the costs of providing credit card services. That is, these costs are incorporated into the selling price of goods and services, and all purchasers pay the same price regardless of whether they used a high or low cost payment instrument.

The interchange fee arrangements and ‘no surcharge’ rules help to explain why margins of revenues over average costs in credit card issuing have not been competed away. In the case of credit card acquiring, the explanation for the high margins may lie more in the restrictions on access to the credit card schemes. Although acquiring is largely a processing business, the rules in credit card schemes restrict acquiring to authorised deposit-taking institutions, preventing non-deposit takers from competing. This



restriction spills over into debit card acquiring, because merchants generally want to deal with an acquirer which can acquire all credit and debit cards. Membership restrictions in, and the cost of entry to, the Bankcard scheme further limit the scope for new entrants to compete away the margins in acquiring.

In debit card acquiring, large merchants that have invested in acquiring infrastructure have had sufficient bargaining power with their acquirers to be able to share the interchange fee received from issuers. As a consequence, acquirers earn lower margins in debit card acquiring than in credit card acquiring. However, small financial institutions wishing to enter the debit card network as issuers or acquirers have limited bargaining power against established players and may need to use more expensive gateway arrangements.

7.3 IMPLICATIONS OF CURRENT ARRANGEMENTS FOR THE CHOICE BETWEEN CREDIT AND DEBIT CARDS

A major consequence of current interchange fee and access arrangements in Australia is that the credit card network has been encouraged to grow at the expense of a less costly alternative, the debit card. The costs of these two payment networks, outlined in earlier Chapters, are summarised in Table 7.1. The differences in the resources required to provide credit and debit card transactions are substantial. The total resource costs to acquirers and issuers of a \$100 credit card payment is \$2.36. Included in this figure is \$0.35 per transaction for credit losses, a proportion of which is associated with use of the revolving credit facility; excluding these credit losses, the cost of a \$100 credit card transaction is \$2.01. This is five times the cost of a debit card

Table 7.1: Costs of payment networks

	Per \$100 transaction		Annual cost (1999/2000, \$A million)	
	Credit card	Debit card	Credit card	Debit card
Acquiring costs	0.43	0.26	271	165
Issuing costs (ex credit losses)	1.93 (1.58)	0.15	1 209 (993)	89
Total costs (ex credit losses)	2.36 (2.01)	0.41	1 480 (1 264)	254



transaction for the same amount, which is \$0.41. On the same basis, a \$1 000 credit card transaction costs almost 13 times more than a transaction for the same amount using a debit card.

Given these differences, the current mix of payment instruments involves a substantial resource cost to the Australian economy. Over 1999/2000, for example, Australians made around 620 million credit card transactions at a total resource cost (excluding credit losses) a little below \$1.3 billion. The total cost of the 635 million debit card transactions over the same period was \$254 million.

Consumers make decisions about which payment instrument they use on the basis of factors such as convenience, the type of payment being made, personal preferences and the relative prices of alternative instruments. In many circumstances, a debit card is a close substitute for a credit card for cardholders who do not face a cash constraint. For these cardholders, the choice between the two types of card will be heavily influenced by their relative price and other incentives.

The typical incentives for a cardholder to use a debit card or a credit card as a payment facility are shown in Table 7.2. For comparison purposes, the incentives have been expressed as an amount per \$100 transaction.⁴³ The cost of using a debit card will depend on the number of fee-free transactions to which a cardholder is entitled. At best the cost will be zero; for transactions beyond the fee-free threshold, the cost of using a debit card averages around \$0.60 per transaction. In contrast, the cost to cardholders of using a credit card is negative; that is, they are effectively paid to use

Table 7.2: Cardholder costs of using debit and credit cards (\$A)

	Credit card payment	Debit card payment
Transaction fee	—	0.0 or 0.60
Interest free period	-0.42	—
Loyalty points	-0.30 to -0.62	—
Total	-0.72 to -1.04	0.0 or 0.60

43. The table excludes annual fees for credit cards and monthly account-keeping fees for deposit accounts. These are fixed costs and not relevant to the decision about which card to use for an individual transaction.



the card. Cardholders with a standard credit card pay no transaction fees, they gain the benefit of interest-free credit⁴⁴ and they may be eligible for loyalty points, on which issuers outlay between \$0.30 and \$0.62 for a \$100 transaction. On these figures, the incentives for a cardholder to use a credit card (measured as the cost to the card issuer) can be as much as \$1.04 for a \$100 transaction.

From the viewpoint of the merchant, a debit and a credit card both provide a guaranteed, pre-authorised payment. Nonetheless, the merchant service fee it pays can differ significantly between the two types of cards. For a \$100 transaction, the merchant service fee for accepting a credit card averages \$1.78. For a debit card, the fee may be around \$0.80 for merchants which do not provide any acquiring infrastructure; merchants which operate their own infrastructure receive a share of the interchange paid to their financial institution by issuers and hence receive revenue from accepting debit cards. 'No surcharge' rules in credit card schemes prevent merchants from passing on to cardholders the relatively high payment costs they face for accepting credit cards vis-à-vis debit cards.

With this structure of incentives, it is no surprise that credit card usage has grown strongly over the past few years. Part of the increase may have been at the expense of cash, but credit cards are also substituting for other non-cash payment instruments. Grocery stores, for example, did not start accepting credit cards until the mid 1990s; since then, growth in debit card payments in these stores has begun to taper off while credit card payments have been rising sharply. Credit cards are also being used increasingly for routine bill payments. Where credit card payments displace cash and cheques, there may be resource savings for the community. However, credit card payments are also growing in place of payment instruments which are less costly to provide – in particular, debit cards and direct debits.

In summary, the pricing of retail payment services in Australia, in which interchange fees play an integral role, is distorting the payment choices facing consumers. The beneficiaries are credit cardholders using the credit card purely as a payment instrument, who are not contributing fully to cost recovery, and financial institutions which are members of the credit card schemes, which earn substantially higher margins from the provision of credit card services than from debit card services. Australia as a whole, however, has a higher cost retail payments system than is necessary, and much of this higher cost is borne by consumers who do not use credit cards.

Australia has well-established ATM, credit card and debit card networks. Each of these networks operates to a high standard of technical efficiency, and has widespread

44. A \$100 purchase made on the 15th day of a 30-day billing cycle, with a 15-day grace period, would be paid off 30 days after the purchase. At an interest rate of five per cent, the cost to the card issuer of funding this benefit would be around \$0.42.



customer acceptance. Interchange fees may have played an important part in the development of these networks, but by their nature they have done so by reducing the potency of the normal market mechanisms which determine consumer choice and resource allocation. While a pricing system based on interchange fees still seems to be the most practical arrangement for the credit card network, the levels of interchange fees are high relative to costs and fees of this magnitude are not essential to the continued viability of this network. For the other networks – ATMs and debit cards – alternative pricing arrangements exist under which providers of card services could recoup their costs directly from users, as they do with other payment instruments.





REFERENCES

- Australian Payments System Council (1996), *Annual Report 1995/96*, Reserve Bank of Australia.
- Balto, D.A (2000), 'The Problem of Interchange Fees: Costs without Benefits', *European Competition Law Review*, Vol. 21, No. 4, April, pp. 215-224.
- Bank for International Settlements (1999), *Payment Systems in Australia*, Basel, July.
- Bank for International Settlements (2000), *Statistics on Payment Systems in the Group of Ten Countries*, figures for 1998, Basel, February.
- Baxter, W.F (1983), 'Bank Interchange and Transactional Paper: Legal and Economic Perspectives', *Journal of Law and Economics*, Vol. 26, October, pp. 541-588.
- Bullock, M and L Ellis (1998), 'Some Features of the Australian Payments System', Reserve Bank of Australia *Bulletin*, December.
- Carlton, D and A Frankel (1995), 'The Anti-trust Economics of Credit Card Networks', *Antitrust Law Journal*, Vol. 63, No. 3, pp. 903-915.
- Cruickshank, D (2000), *Competition in UK Banking*, HMSO, Norwich, March.
- Damania, D (1989), *Credit Card Pricing in Australia*, A Report Prepared for The Standing Committee of Consumer Affairs Ministers, Flinders University.
- Evans, D and R Schmalensee (1993), *The Economics of the Payment Card Industry*, National Economic Research Associates, Inc., Cambridge.
- Evans, D and R Schmalensee (1995), 'Economic Aspects of Payment Card Systems and Antitrust Policy Toward Joint Ventures', *Antitrust Law Journal*, Vol. 63, No. 3, pp. 861-901.
- Evans, D and R Schmalensee (1999), *Paying with Plastic*, MIT Press, Cambridge.
- Financial System Inquiry Final Report* (1997), AGPS, Canberra.
- Frankel, A (1998), 'Monopoly and Competition in the Supply and Exchange of Money', *Antitrust Law Journal*, Vol. 66, No. 2, pp. 313-361.
- Gaudion, I and G Rennie (1989), *A Report on the Economics of Credit Card Operations*, Prepared for the Minister for Consumer Affairs Victoria, August.



Hancock, D and D Humphrey (1998), 'Payment transactions, instruments, and systems: A survey', *Journal of Banking and Finance*, Vol. 21, pp. 1573-1624.

Kitch, E (1990), 'The Framing Hypothesis: Is it Supported by Credit Card Opposition to a Surcharge on the Cash price?', *Journal of Law, Economics and Organisation*, Vol.6, No.1, pp. 217-233.

McAndrews, J (1998), 'ATM Surcharges', *Current Issues in Economics and Finance*, Vol. 4, No. 4, Federal Reserve Bank of New York, April.

Prices Surveillance Authority (1992), *Inquiry into Credit Card Interest Rates*, Canberra, October.

Prices Surveillance Authority (1994), *Monitoring of Credit Card Pricing*, No. 1, Canberra, April.

Prices Surveillance Authority (1995a), *Monitoring of Credit Card Pricing*, No. 2, Canberra, May.

Prices Surveillance Authority (1995b), *Inquiry into Fees and Charges Imposed on Retail Accounts by Banks and Other Financial Institutions and by Retailers on EFTPOS Transactions*, Canberra, June.

Reserve Bank of Australia (1999), 'Bank Fees in Australia', *Reserve Bank of Australia Bulletin*, June.

Reserve Bank of Australia (1998), Memorandum of Understanding between the Australian Competition and Consumer Commission and the Reserve Bank of Australia, September.

Reserve Bank of Australia (2000), 'Notes on Bank Fees in Australia', submitted to the House of Representatives Standing Committee on Economics, Finance and Public Administration, 22 May.

Rochet, J and Tirole, J (1999), 'Co-operation among Competitors: The Economics of Credit Card Associations', *Centre for Economic Policy Research Discussion Paper*, No. 2101, March.

Schmalensee, R (1999), 'Payment Systems and Interchange Fees', mimeo, MIT, March.