

# FINANCIAL STABILITY REVIEW

March 2008

---

## CONTENTS

- 1 Overview
- 3 The Global Financial Environment
  - 16 Box A: Financial Guaranty Insurers (Monolines)
  - 18 Box B: The ABX.HE Credit Default Swap Indices
- 23 The Australian Financial System
- 47 Household and Business Balance Sheets
  - 61 Box C: Survey-based Indicators of Household Finances
  - 63 Box D: Market Risk in the Household Asset Portfolio
- 65 Developments in the Financial System Infrastructure

*Reserve Bank*

*Financial Stability Review* enquiries

*Media Office*

Telephone: (612) 9551 9721 or 9551 9731

Facsimile: (612) 9221 5528

E-mail: [rbainfo@rba.gov.au](mailto:rbainfo@rba.gov.au)

The material in this *Financial Stability Review* was finalised on 25 March 2008.

The *Financial Stability Review* is published semi-annually in March and September.

It is available on the Reserve Bank's website ([www.rba.gov.au](http://www.rba.gov.au)).

The *Review* uses data from the Household, Income and Labour Dynamics in Australia (HILDA) Survey, which was initiated and is funded by the Australian Government Department of Families, Community Services and Indigenous Affairs (FaCSIA), and is managed by the Melbourne Institute of Applied Economic and Social Research (MIAESR). The findings and views reported in this publication should not be attributed to either FaCSIA or the MIAESR. For copyright and disclaimer notices relating to data in the *Review* see the Bank's website.

ISSN 1449-3896 (Print)

ISSN 1449-5260 (Online)

# Overview

The global financial system is currently under more strain than it has been at any time since at least the early 1990s. It is dealing with both a significant repricing of many financial assets and the unwinding of some of the leverage built up during the preceding boom. There has also been a marked rise in uncertainty about the economic outlook and the strength of financial institutions, particularly in the United States. While the strains originated in the US sub-prime residential mortgage market, they have become much more pervasive over recent months.

The current repricing of assets reflects a sharp increase in risk aversion, a re-appraisal of the underlying risks of many investments, and the sale of assets as some borrowers are required to reduce their leverage. These adjustments follow a prolonged period during which credit risk was widely perceived to be low, and during which investors were prepared to finance the purchase of assets with high levels of debt. It has also led to a number of the world's major financial institutions announcing significant write-downs. In addition, conditions in many financial markets – particularly the asset-backed-paper markets – have been very unsettled, with issuance of new securities falling markedly.

As a result of these developments, confidence in the global financial system is more brittle than it has been for some time. Bank share prices in many countries are down by around one third from their levels of a year ago, and spreads on bank debt have increased significantly. Investors have also exhibited a strong preference for short-term assets, requiring especially large premiums on long-term debt. Further, in the United States and Europe, changes of ownership have been required for a small number of financial institutions experiencing difficulties.

The various strains have led to a tightening of credit conditions in many developed countries and interest rate margins over risk-free rates have also increased significantly. Many financial institutions have also had pressure on their funding and capital positions as they have provided financing to previously off-balance sheet vehicles that were unable to continue funding their illiquid assets in the short-term money markets. Against this general background, many central banks have modified their liquidity operations in domestic money markets, and monetary policy has been eased significantly in the United States.

In Australia, the financial system has coped better with the recent strains than have the financial systems of many other countries. The banking system remains highly profitable and well capitalised, with the banks having minimal direct exposure to the sub-prime problems in the United States. The credit ratings of the larger banks remain high, with none of them having been put on negative credit watch or having their ratings downgraded. This strong standing of the banks has contributed to rapid growth in their deposits over the past six months, and they continue to be able to raise significant volumes of funds in both domestic and international capital markets.

The solid position of the Australian banking system partly reflects the high quality of its assets, with the banks having considerably less risky portfolios than banks in many other

countries. Ratios of non-performing loans to total loans remain at low levels, with arrears rates having declined over the past six months. While lending criteria were relaxed over recent years, credit standards in Australia did not fall by nearly as much as they did in the United States. The banks also typically take relatively small open positions in financial market instruments relative to the size of their balance sheets, and relative to many international banks.

Notwithstanding this favourable position, the changed credit environment has had a significant impact on the Australian financial system. As is the case in other countries, bank share prices are down considerably and funding costs have risen significantly. These higher funding costs have been largely passed through to business borrowers. Lenders have also increased their mortgage indicator rates by more than the rise in the cash rate, after these rates had moved together for the past decade. In addition, lenders have tightened credit standards, particularly to firms with complex and highly leveraged balance sheets.

These changes in the cost and availability of funding are having a significant effect on the nature of competition within the system. In particular, the market for securities backed by housing loans has been disrupted, with new issuance drying up. As a result, lenders that rely on this market for their funding are finding conditions much more difficult than those that rely more heavily on deposit and other markets.

The tighter financial conditions in Australia are having an impact on both household and business finances, although overall balance sheets remain in good shape. Recently, the household sector has benefited from favourable labour market conditions and strong income growth and, over the past decade, has experienced a significant increase in its net wealth relative to income. Reflecting these developments, the share of households not able to meet their debt obligations is low by both historical and international standards. There are, nonetheless, some pockets of stress, with higher interest rates and weaker asset markets putting more pressure on many households' finances than has been the case in recent years, and loan arrears are likely to rise from the current low rates in the period ahead.

The favourable macro-economic conditions of recent years have also meant that, at the aggregate level, business balance sheets are in a healthy shape: profitability is high, and both debt-servicing requirements and arrears rates are at relatively low levels. Notwithstanding this positive picture, the recent sharp increase in risk aversion and higher funding costs have created difficulties for some firms, particularly those with highly leveraged balance sheets, and those that have relied heavily on short-term funding.

Despite the strains in global financial markets, the underlying resilience of the Australian financial system, together with the relatively favourable outlook for the domestic economy, means that the system is much better positioned than the financial systems of many other countries to cope with the current difficulties. ✎

# The Global Financial Environment

The past six months have been the most difficult for much of the global financial system for many years. The system is having to deal simultaneously with a significant repricing of risk, a marked rise in uncertainty about the economic outlook and the strength of financial institutions, and an unwinding of some of the leverage that was built up during the preceding boom. The catalyst for the adjustment was deteriorating credit conditions in the US sub-prime mortgage market, but the effects have become pervasive since the turmoil began.

At the heart of the current adjustment is a repricing of many financial assets. This repricing stems from at least two inter-related factors. The first is an increase in risk aversion, with investors requiring more compensation for holding an asset with a given risk of default. And the second is that many assets are now simply seen to be more risky. These changes in attitude have led to very large declines in the prices of many financial assets, particularly structured credit products with exposure to US sub-prime mortgages. In some cases, the price declines have been exacerbated by the sale of assets required to unwind leveraged structures.

These price declines have come after a number of years in which there were concerns about the underpricing of risk and, in particular, the apparent willingness of investors to invest in highly leveraged structures. Clearly some adjustment in prices and the terms under which finance was available was required. Such changes, however, rarely occur smoothly, particularly after a long boom in both the real economy and the financial sector. Perhaps not surprisingly, the global financial system has moved quickly from a situation in which risk aversion was very low to one in which it is very high, and from one in which assets appeared to be priced for 'perfection', to one in which pricing often appears to be based on quite pessimistic scenarios. The changes have led investors to question a number of aspects of the financial system, including the sustainable level of spreads on a whole range of financial assets, and the long-term viability of a variety of financial structures and business models that had become commonplace over recent years.

There is a high degree of uncertainty in the current global environment that is serving to prolong the adjustment process. This has at least three inter-related dimensions. The first is the uncertainty about the health of financial institutions, mainly banks, but also, more recently, bond insurers. The second is uncertainty about the performance of various structured credit products, given their complex nature. And the third main source of uncertainty relates to the economic outlook, and particularly the prospects for the housing market in the United States.

## **Banks' Liquidity and Funding Conditions**

As noted in the previous *Review*, one of the main areas of concern in the initial phases of the turmoil related to banks' liquidity, as banks were called upon to honour lines of credit they had offered to a range of structures that were having difficulty rolling over their existing liabilities. The need to provide this credit stemmed from problems in the asset-backed commercial paper (ABCP) market, which came under intense pressure early in the turmoil as investors shunned commercial paper backed by sub-prime mortgages, and eventually all types of ABCP. From

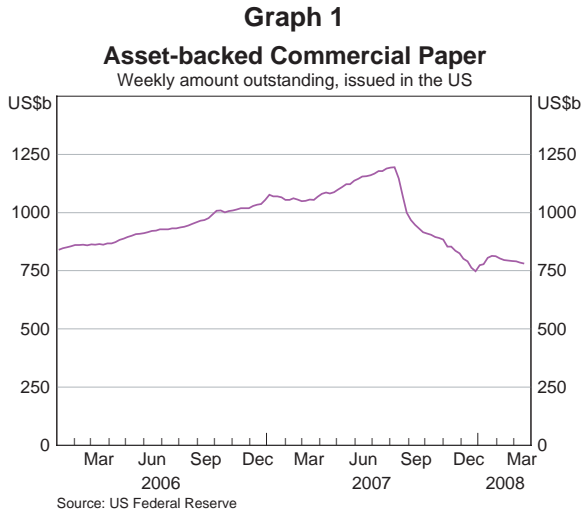

a peak of about US\$1.2 trillion last August, the value of ABCP outstanding in the United States fell by nearly 40 per cent, to a low of about US\$750 billion in December, before stabilising in recent months (Graph 1). Spreads between 30-day ABCP and overnight indexed swap (OIS) rates in the United States, which had typically been very close to zero, reached 200 basis points at one point in December 2007, but have subsequently declined to around 70 basis points.

The dislocation in the ABCP market has resulted in a period of significant adjustment for the vehicles that are most reliant on this market for their funding, particularly conduits and structured investment vehicles (SIVs), which had been set up by some banks to finance assets off their balance sheets. Some of these vehicles had to draw on the back-up liquidity lines they had arranged with banks, while others were forced to sell assets to repay maturing ABCP. SIVs came under the most pressure as many did not have liquidity lines with banks, and some of them have defaulted. In an effort to avoid a ‘fire sale’ of assets, a consortium of international banks began working on plans in late 2007 to establish a large fund to support the SIVs. These plans eventually broke down however, with some of the sponsoring banks instead winding these vehicles down, including by bringing them on to their own balance sheets.

As noted in the previous *Review*, the concerns over the extent to which the banks’ commitments would be drawn down, in addition to growing uncertainty about the likely scale and distribution of sub-prime related credit losses, contributed to banks hoarding liquidity, which led to a significant tightening of conditions in inter-bank and short-term money markets in August. This was most evident in the sharp widening of spreads between 3-month LIBOR and risk-free interest rates in a number of countries (Graph 2). Central banks responded to these tensions by injecting liquidity into their banking systems and, in some cases, broadening the range of assets they accepted in their market

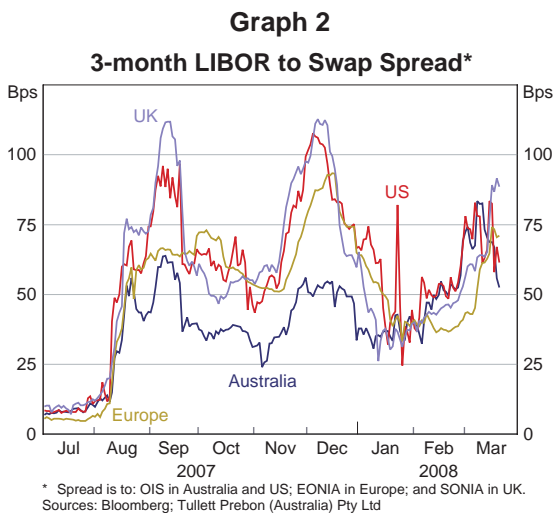

in inter-bank and short-term money markets in August. This was most evident in the sharp widening of spreads between 3-month LIBOR and risk-free interest rates in a number of countries (Graph 2). Central banks responded to these tensions by injecting liquidity into their banking systems and, in some cases, broadening the range of assets they accepted in their market

operations. In September, the US Federal Reserve also embarked on a series of interest rate cuts, which has so far seen the Federal funds rate reduced by a cumulative 3 percentage points, to its lowest level since early 2005.

While these actions saw inter-bank spreads fall partially back in September and October, they widened sharply again late in the year, following news of large credit write-downs by a number of global banks and increasing anxiety about banks' year-end funding requirements. These renewed tensions prompted further liquidity injections, including a co-ordinated operation by a number of central banks. The US Federal Reserve, the European Central Bank and the Swiss National Bank also put in place reciprocal swap agreements, mainly to assist European banks experiencing difficulty accessing US dollar liquidity, while the Federal Reserve introduced a 'term auction facility' to provide liquidity against a wider range of collateral and to a broader range of counterparties than in its usual operations.

Together with the passing of year-end funding pressures, the various central bank operations contributed to a narrowing of inter-bank spreads in late December and January, but spreads have remained volatile and moved higher again in the period since, though generally not to the same extent as in the earlier episodes. Since mid March, the 3-month LIBOR to OIS spreads in the United States and Europe have fluctuated in a range of about 60 to 90 basis points, compared to an average of around 10 basis points in the period prior to August 2007. The persistent strains are prompting ongoing efforts by major central banks to supply liquidity, including through the introduction of new facilities, and through the expansion of existing facilities, making funds available to a wider range of market participants, for longer periods, and against a broader range of assets.

With liquidity pressures still evident in short-term funding markets, many longer-term funding markets are also experiencing difficulties. Issuance of residential mortgage-backed securities (RMBS) has declined sharply since the turmoil began, and spreads have widened significantly. In the United States, only US\$67 billion of non-agency RMBS was issued in the fourth quarter of 2007, compared with a quarterly average of about US\$200 billion over the past couple of years (Graph 3). Issuance of sub-prime RMBS has fallen particularly sharply, by about 90 per cent over the year to the December quarter 2007. The strains in RMBS markets have also been evident in a number of other countries, including Australia (see *The Australian Financial System* chapter). The markets for more complex structured credit products, such as collateralised debt obligations (CDOs), have also been under considerable pressure due to widespread investor distrust of these instruments. In the fourth quarter of 2007, there was just US\$60 billion of CDOs issued in the United States, down from US\$250 billion a year

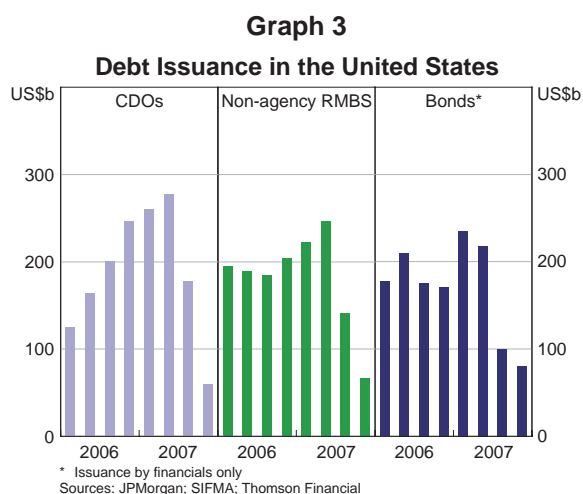

earlier. The decline in issuance has been particularly pronounced for structured finance CDOs, which includes CDOs composed of RMBS, other asset-backed securities, or other CDOs. Banks' issuance of bonds in their own names has also declined since the turbulence began, though generally not to the same extent as structured products. Overall, spreads on all debt instruments have widened considerably, resulting in a sharp rise in the cost of funding for banks, which is being passed on to many borrowers.

The funding requirements of some banks are being added to by the difficulty they are having on-selling some of the leveraged buyout-related loans they had made last year; currently, banks are estimated to be sitting on about US\$150–200 billion of such loans. Together with the general increase in credit spreads, this has prompted some banks to begin taking haircuts on these loans in order to sell them.

It was in this environment of tighter funding conditions that emerged last August that the UK bank Northern Rock became concerned about its liquidity position due to its relatively heavy reliance on wholesale funding markets, particularly securitisation. As a result, Northern Rock approached the Bank of England regarding emergency liquidity assistance in early September 2007. Despite there being no immediate solvency concerns, news that the bank had sought assistance from the Bank of England triggered a run on retail deposits, which was only halted when the UK Government provided a guarantee on Northern Rock's deposits. In the ensuing months, the UK authorities sought a private buyer for the stricken bank, but with these attempts having failed, Northern Rock was brought under public ownership in February this year.

In mid March, the ongoing pressures also took their toll on a US investment bank, Bear Stearns, which suffered a significant deterioration in its liquidity position when growing solvency concerns precipitated a sharp withdrawal of funds. This prompted an injection of liquidity by the US Federal Reserve, through JPMorgan Chase, with JPMorgan Chase subsequently announcing its acquisition of Bear Stearns.

## **Credit Write-downs and Capital**

While liquidity was one of the initial concerns, as the turmoil has continued, attention has also focused on underlying credit quality, particularly as some financial institutions began announcing substantial write-downs on their holdings of various structured credit instruments.

From the start of the current episode, it was widely recognised that the adjustment process would be aided by institutions being as transparent as possible about their sub-prime related credit exposures. A number of US and European institutions moved quickly in this regard, reporting significant write-downs in their third-quarter 2007 results. However, confidence has not been helped by some of these same institutions reporting further write-downs in their fourth-quarter results and subsequent earnings updates. The multiple announcements have created concerns that bad news is likely to be followed by further bad news, and the various announcements have not always revealed sufficient information for investors to assess whether the new valuations fully reflect current market conditions. The resulting uncertainty about the scale and distribution of further losses is hindering a return of confidence to the market. One development that would be likely to help confidence would be institutions announcing write-backs to previously announced valuation losses, but this still seems some way off.



In total, since the onset of the turmoil, the major global financial institutions have reported cumulative write-downs of about US\$190 billion on their holdings of various credit instruments. In some cases, these write-downs have resulted in the banks recording overall losses in the most recent reporting period, and some have had their credit ratings downgraded. While the worst affected institutions have been the large global investment banks – for example, Merrill Lynch, Citigroup, and UBS have reported around US\$70 billion of write-downs between them – a number of mid-tier banks in the United States, Europe and Japan, have also reported significant write-downs. In the United States, the write-downs have driven a significant reduction in the return on assets of deposit-taking institutions, to an annualised rate of about 0.2 per cent in the fourth quarter of 2007, compared with an average of about 1.2 per cent over the preceding decade. While this fall has been concentrated among the larger institutions, the average return on assets for smaller US banks also fell, by about one third in the fourth quarter of 2007 compared with the average of the past few years, consistent with a more generalised weakening of bank profitability. Elsewhere, the banking systems in most other major economies have remained quite profitable.

One positive aspect of the recent experience is that when banks have recorded very large losses, they have been able to raise new capital, albeit at a significant cost, leading to a substantial dilution of the interests of the existing shareholders. These capital raisings, including significant injections from Asian and Middle Eastern sovereign wealth funds, have allowed banks reporting losses to maintain, and in some cases increase, their capital ratios. Without these injections, the global financial system would have been in a much more difficult position. Notwithstanding this, there remains a risk that further large write-downs could make a substantial dent in banks' capital. In some cases, capital ratios are also being strained by the banks bringing back on balance sheet assets formerly held in off-balance sheet vehicles, and by increased demand for funding from a range of businesses, some of which have been shut out of the capital markets. While most banking systems, in aggregate, remain reasonably well capitalised by the standards of the past, further deterioration in the economic outlook could put pressure on banks' capital ratios, increasing the probability of a further tightening in the availability of finance. Furthermore, it is not clear to what extent sovereign wealth funds would be as forthcoming with additional capital if further significant losses were announced.

Reflecting the various difficulties being faced by banks, bank share prices have fallen considerably in all of the major economies (Graph 4). Prices are generally down around 30–40 per cent from their levels in mid 2007, compared with falls in overall markets over this period of about 15–25 per cent. The uncertainty about the health

**Graph 4**  
**Banks' Share Prices**  
1 January 2007 = 100

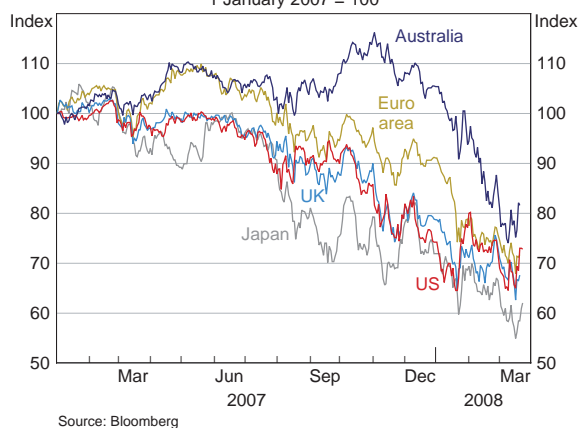

**Graph 5**  
**Banks' Senior 5-year CDS Premia**  
 5-day moving average

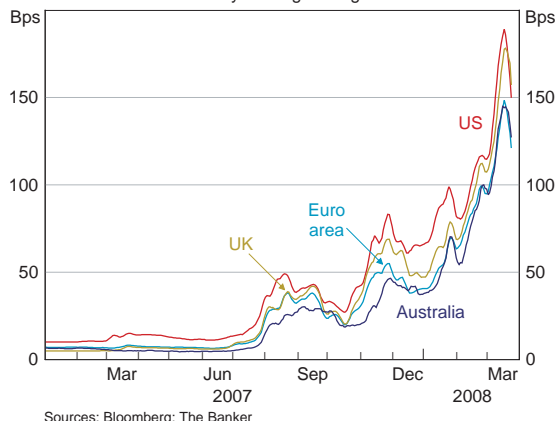

of banks has also contributed to a very sharp increase in their credit default swap premia, with banks in the United States among the worst affected (Graph 5).

While the health of banks has been the focus of much attention, another factor weighing on confidence recently has been the prospects for US ‘monoline’ bond insurers. As discussed in more detail in Box A, in recent years, these insurers have moved beyond their original business of insuring mainly municipal debt, to insuring structured credit products. With this insurance often taking the

form of credit default swaps (CDS), these companies have recorded large mark-to-market losses, which has prompted credit rating agencies to either downgrade, or consider downgrading them. While some have been able to raise new capital, the general consensus in the market is that the industry is under-capitalised, which is prompting various ‘rescue’ efforts.

The downgrade of a monoline insurer raises the prospect of significant mark-to-market losses for investors, with banks estimated to have hedged about US\$125 billion of their holdings of sub-prime related CDOs by entering into CDS with monolines. These contracts are subject to significant counterparty risk, because whereas collateral is normally posted by participants in over-the-counter CDS transactions, typically no collateral was posted if a monoline was the counterparty. Concerns over the health of monolines have led some banks to begin raising provisions or writing off their insurance exposures to these companies.

Another way banks may be affected by the downgrade of a monoline insurer is through the back-up liquidity lines they have provided to investment vehicles that had funded the purchase of long-term insured municipal bonds by issuing bonds able to be put back with the issuer on demand. (This is analogous to the maturity mismatch risk being faced by conduits and SIVs.) If the downgrade of a monoline creates funding difficulties for these vehicles, they may be forced to draw on their back-up liquidity lines, placing further pressure on banks’ liquidity.

## US Mortgage and Housing Markets

As noted in the previous *Review*, it was the deterioration of conditions in the US sub-prime mortgage market that was the initial catalyst for the recent adjustment. As was widely expected, problems in this market have continued to worsen over the past six months. According to data from the Mortgage Bankers Association, by number of loans, the 30-day arrears rate on US sub-prime adjustable-rate mortgages rose from 17 per cent in June 2007 to 20 per cent in December 2007, which is about 5 percentage points above the peak of the previous cycle in 2002 (Graph 6). The equivalent arrears rate for fixed-rate sub-prime mortgages also picked

up fairly sharply over the second half of 2007, to about 14 per cent, after being more contained during the preceding couple of years. While sub-prime mortgages represent about 13 per cent of all US housing loans outstanding, they accounted for more than half of the loans entering foreclosure in the fourth quarter of 2007. While much of the attention has been on the sub-prime market, the 30-day arrears rate on prime mortgages has also increased, though at about 3¼ per cent in December 2007, it is low relative to that on sub-prime loans. The increase in delinquency rates on US mortgages has contributed to a sharp rise in the number of foreclosures, which was up around 60 per cent over the year to the December quarter 2007.

Much of the increase in US mortgage defaults has been due to borrowers being unable to meet the higher loan repayments after their rates reset following the expiration of introductory discount periods, though this problem has been alleviated somewhat by the relaxation of US monetary policy. Recent falls in house prices have also contributed to mortgage defaults as many borrowers that took out loans with little or no downpayment now have negative equity. According to the S&P/Case-Shiller index, average house prices in the 20 large US cities covered by the index have fallen by about 10 per cent from their peak in mid 2006, with the pace of decline accelerating in the second half of 2007 (Graph 7).

In response to the problems in the US sub-prime mortgage market, a number of initiatives have either been introduced, or are being considered, to assist distressed borrowers. These include temporary freezes on interest rates for borrowers subject to resets and possible changes to bankruptcy laws to allow mortgages to be reduced to the market value of the house.

Lenders in the United States have tightened the availability of mortgage credit in response to the more difficult financial environment. The loan officer survey conducted by the US Federal

**Graph 6**  
**US Mortgage Delinquency Rates**  
30+ days past due, per cent of outstandings

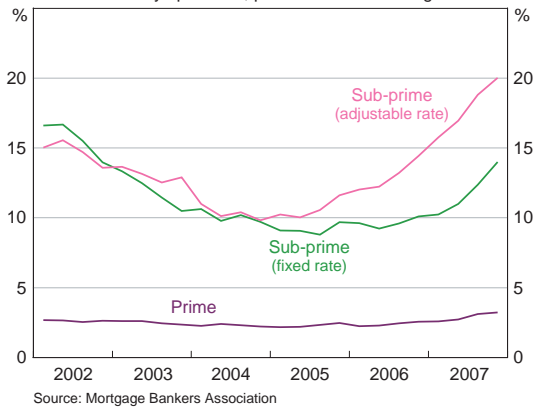

**Graph 7**

**US House Prices**  
End December 2000 = 100

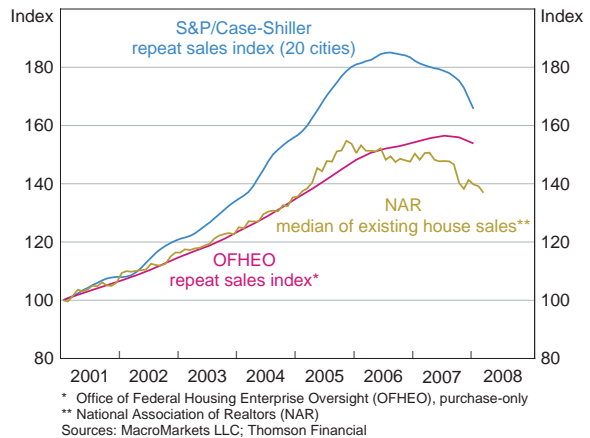

**Graph 8**

**Credit Standards for Residential Mortgages**

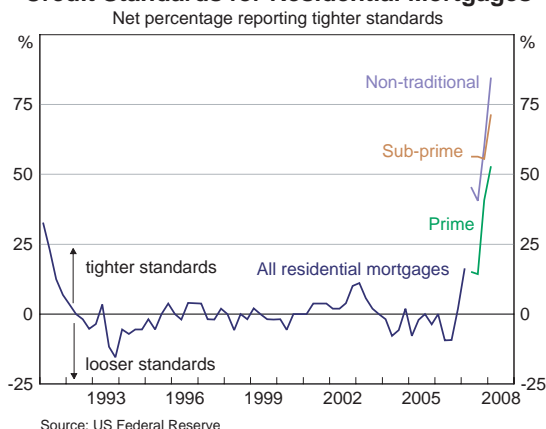

Reserve in January 2008 showed the highest proportion of US banks tightening their lending standards for residential mortgages since the survey began in 1990 (Graph 8). This was most evident for sub-prime and other non-traditional mortgages, but even for prime mortgages, standards were reportedly tightened by more than half of the respondent banks over the three months to January 2008. The tightening of lending standards has been evident in a slowing of mortgage credit growth in the United States. From a peak of around 14 per cent in the first half

of 2006, year-ended growth in mortgage credit in the United States slowed to about 7 per cent in December 2007.

A major factor determining how conditions in the US mortgage markets play out in the near future is likely to be the performance of the US housing market. The larger is the decline in house prices, the greater will be the number of foreclosures, and the larger will be the losses on RMBS and the structured instruments that have been developed based on these securities. The central scenario for many involves a further modest decline in house prices, with prices stabilising later in the year. In contrast, a more pessimistic scenario is one in which house prices continue to fall, leading to further difficulties for the financial system, which, in turn, lead to a significant reduction in credit supply, contributing to further downward pressure on house prices. The result could then be a self-reinforcing cycle, with increasing losses and very weak outcomes. Of course, it is possible that the US Federal Reserve would respond to such a weak scenario by further easing monetary policy.

The current market pricing of various mortgage-related structured credit instruments appears to be consistent with a very pessimistic scenario. For example, as discussed in more detail in Box B, the prices of the ABX.HE indices of credit default swaps on US sub-prime RMBS have declined significantly over the past year or so, even the prices of those indices that reference the highest-rated tranches. Current prices imply losses on the underlying RMBS – including AAA-rated tranches – many times greater than historical experience. While many financial institutions have used these indices to value their holdings of a wide variety of sub-prime related credit instruments, a number of market participants have questioned whether the large price falls accurately reflect the likely losses on the underlying mortgages.

### **Impact on Non-financial Businesses**

Concern about the impact of the turmoil on non-financial businesses has primarily focused on the possibility of reduced availability of credit as well as the general uncertainty and pessimism regarding the macroeconomic outlook. Banks' losses and funding difficulties have raised

concerns about the emergence of a broad-based ‘credit crunch’, even though there is little sign as yet of slower growth in business credit in most major economies. While some tightening of lending standards is a welcome development given the problems that arose from lax lending standards in the sub-prime mortgage market, there is a risk that lending standards could swing too far in the opposite direction, restricting the availability of credit to creditworthy borrowers and thereby exacerbating any economic slowdown.

As with banks, non-financial companies in many countries have been affected by the tighter conditions in wholesale funding markets, including in Australia (see the chapter on *Household and Business Balance Sheets*). Corporate bond issuance has fallen since the turmoil began, especially among lower-rated issuers, and spreads on corporate bonds of all ratings have widened to their highest levels since earlier this decade (Graph 9). For lower-rated companies in the United States, the rise in spreads has exceeded the reduction in government bond yields associated with the easing of monetary policy, resulting in an overall increase in the cost of debt. Similarly, spreads on CDS for both investment grade and sub-investment grade companies in the United States and Europe have risen sharply over the past six months, though the increases in spreads have tended to be smaller for non-financial companies than for equivalently rated financial institutions.

As businesses have faced difficulty tapping capital markets they have been turning to banks, placing additional pressure on banks’ liquidity and capital. Reflecting this, growth in business credit, which had already been quite strong in most major countries in recent years, tended to strengthen further in the second half of 2007 (Graph 10).

While this has seen a generalised increase in business sector gearing, gearing is still low by historical standards in most major economies, and interest-servicing ratios are also generally lower than a decade ago. One exception is the United Kingdom, where business gearing and interest-servicing ratios have risen markedly in recent years, to above long-run averages.

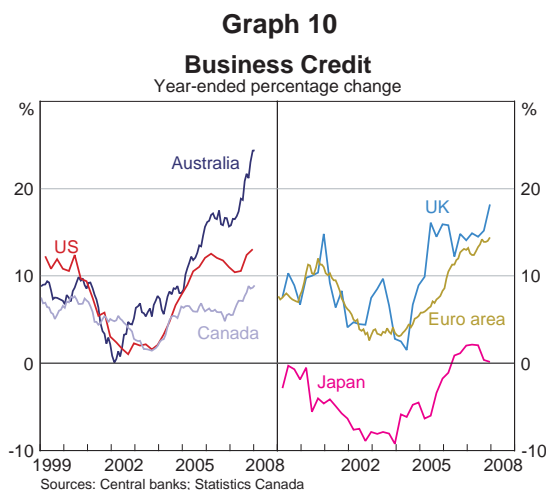
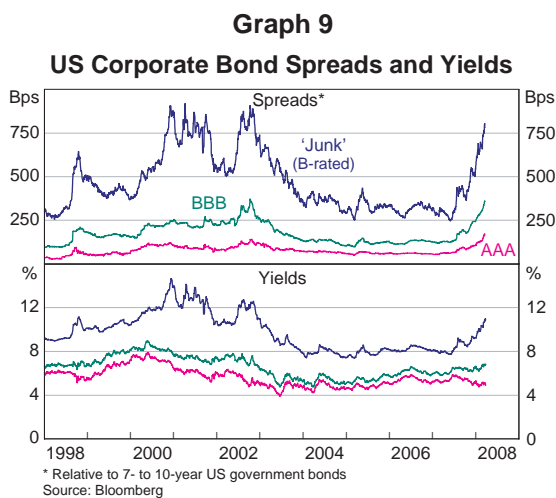

**Graph 11**  
**Global LBO Activity**  
 Announced and completed

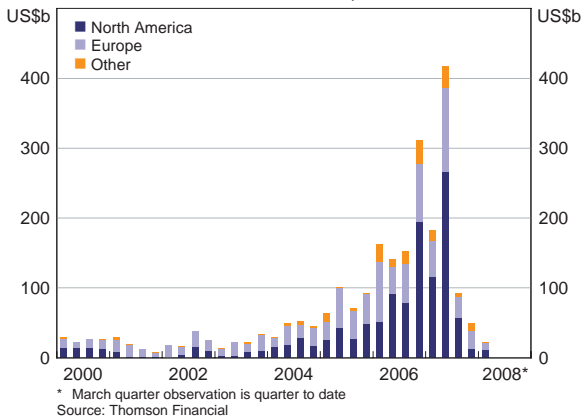

The less receptive funding environment and tighter lending standards are likely to have a larger impact on companies that are more highly geared and/or reliant on short-term financing. Consistent with this, the value of leveraged buyouts (LBOs) fell sharply in the second half of 2007 (Graph 11). The difficulties in the LBO market have also been evident in the spreads on CDS indices referencing leveraged (high-yield) loans, which have nearly tripled since the middle of 2007.

Commercial property markets have also been showing some signs of weakness in a number of countries, particularly the United Kingdom and United States. Delinquency rates on commercial property loans in the United States rose over the course of 2007 and banks have been reporting tighter lending standards on these loans. Heightened concerns have been reflected in the deteriorating performance of indices that track CDS on US commercial mortgage-backed securities, even though there have been relatively few actual defaults on these securities. The *Household and Business Balance Sheets* chapter discusses developments in the Australian commercial property market.

So far, the higher cost of debt and weaker economic conditions have resulted in only a slight increase in Moody's global speculative-grade corporate default rate from the 25-year low reached late last year. However, the rating agency is projecting a sharp increase in defaults, to over 5 per cent, over the next two years as the global economy slows and refinancing becomes more difficult, though this would still be well below the earlier cyclical peaks in this series in 2002 and 1991.

**Graph 12**  
**International Share Prices\***  
 1 January 2007 = 100

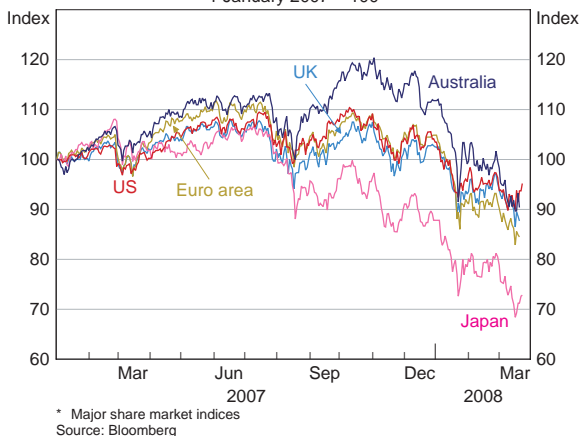

In addition to the poor credit outlook, strains have also been evident in weak equity markets, to a large extent reflecting the deterioration in the economic outlook in the United States and the associated downward revisions to company earnings (Graph 12). As noted earlier, financial institutions have accounted for a lot of the weakness in share prices, though even excluding financial stocks, share markets are noticeably below their

earlier peaks. In the major industrialised countries, the broad share market indices have fallen by about 15–25 per cent since October 2007, with a particularly sharp sell-off experienced in the second half of January, and are now generally below their levels at the beginning of 2007. As with most other financial assets, measures of volatility in equity markets are elevated.

## Macroeconomic Outlook

The adjustment in the global financial system is occurring after a number of years in which the world economy has grown faster than trend, although, as noted in the most recent *Statement on Monetary Policy*, the adjustment is prompting a weakening in the growth outlook. Reflecting this, Consensus forecasts of world GDP growth in 2008 have been revised down since the previous *Review*, to 4.2 per cent, with the Reserve Bank's forecast for world growth somewhat weaker than this. While growth in the major developed economies is expected to slow to well below its average rate, the overall growth outlook is being underpinned by more favourable conditions in many developing economies, particularly China, India and the smaller east Asian economies, which are continuing to grow strongly.

In response to concerns about slower economic growth and the impact of the credit market turmoil, several central banks have eased monetary policy in the past six months, most notably the US Federal Reserve, with financial markets currently pricing in lower interest rates in the euro area, United Kingdom and the United States (Graph 13).

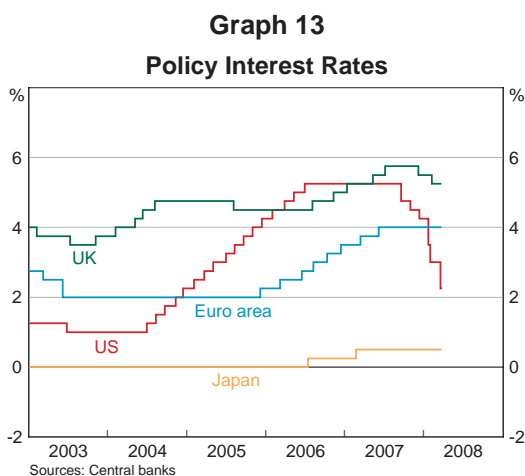

## International Regulatory Response

The ongoing adjustments are attracting close attention from various national and international regulatory and supervisory bodies. This work is attempting to both diagnose the weaknesses that contributed to the recent events and formulate appropriate policy responses. A main coordinating body is a working group established by the Financial Stability Forum and comprising representatives from various national authorities, the chairs of international supervisory, regulatory and central bank bodies and representatives from the Bank for International Settlements and International Monetary Fund. This group issued an interim report in early February, with a final report due in April.

Views on the underlying causes of the turmoil and on the factors that amplified its effect have tended to coalesce around a few main areas. At a fundamental level, the episode can be seen to be the outcome of a prolonged period of unusually benign macroeconomic conditions and low interest rates that bred a perception that risk was low. The combination of solid economic

growth and low interest rates supported rising asset prices, a willingness of investors to seek higher-yielding assets, and a preparedness to borrow to purchase both real and financial assets. At the same time, financial institutions engaged in ever more complex financial engineering to create the higher-yielding products that investors were seeking. Although these products had never been tested in a downturn, investors were apparently willing to buy them on the assumption that the benign conditions of recent years could continue.

A number of specific weaknesses also played a role in the build-up of exposures, including the following:

- poor underwriting and some fraudulent practices in the US sub-prime mortgage market;
- deficiencies in financial institutions' risk management practices, particularly in relation to liquidity risks;
- a lack of transparency and disclosure of risks in relation to complex structured credit products that contributed to shortcomings in the modelling and valuation of these instruments;
- poor investor due diligence, including over-reliance on credit rating agencies and poor understanding of the nature of ratings;
- poor performance of credit rating agencies in relation to assessing and disclosing the risks associated with structured credit instruments; and
- various incentive distortions, including the incentives in the Basel I capital framework that appear to have encouraged some financial institutions to securitise assets for capital relief. There were also weak incentives for parties in the originate-and-distribute model to properly assess and monitor the creditworthiness of the end borrowers.

While there is a range of policy responses being considered, attention has tended to focus on four main areas.

One of these is the shortcomings in the originate-and-distribute model, and in particular how to overcome the incentive problems that can arise when those originating loans do not bear the consequences of poor underwriting standards. Up until recently, one argument was that pressure from the investor side was sufficient, as investors would limit funding to originators with either poor disclosures or poor underwriting practices. Recent events, however, have largely discredited this argument. Many investors simply relied on the credit rating agencies to evaluate complex instruments and, in an environment in which risk was perceived to be low, investors were attracted to the modestly higher yield offered by these securities. This inadequate due diligence created an environment in which originators were able to easily package and distribute loans via securitisation, having only a weak incentive to assess and monitor the creditworthiness of the underlying borrowers.

The policy responses under discussion have focused on the need to improve the transparency of the securitisation market and the accountability of participants. There is a broad consensus that more information needs to be provided to investors, including about the underwriting standards for the underlying assets, and the performance of the assets after they have been originated. Already, there are signs that data providers are mobilising to address some of these gaps. In addition, there have been calls for greater standardisation and reduced complexity of structures, thereby making it easier for investors to assess risk, rather than to rely on credit



rating agencies. Proposals to better align the incentives of credit originators have mostly centred on requiring them to retain some financial exposure to the products they securitise.

A second area of focus is the role of credit rating agencies. Here the concerns have mainly related to perceived inadequacies in the ratings of structured credit instruments and the (not unrelated) potential for conflicts of interest to arise from the fact that rating agencies are remunerated by the issuers of the securities they rate.

One of the problems highlighted by recent events is that many investors appeared to view a AAA rating assigned to a CDO the same as a AAA rating assigned to a conventional corporate bond, whereas the former was significantly more risky than the latter. Indeed, one interpretation of recent events is that some of the financial engineering over recent years was to take advantage of this misunderstanding, rather than to tailor products to the precise risk preferences of particular investors. There is now considerable pressure on rating agencies to provide greater disclosure about the assumptions and approach underlying their rating of structured credit instruments. The rating agencies themselves have taken some steps in this regard and have proposed introducing different rating scales for structured credit products than those used for conventional bonds, and possibly including an assessment of non-default factors such as liquidity risk. To help address the potential for conflicts of interest, there have also been suggestions that agencies should be prohibited from giving advice on the design of structured products they also rate.

A third area receiving close attention is the liquidity management of private banks and the supervisory approach towards liquidity risk management. It is now widely recognised that, over recent years, too little attention had been paid to liquidity risk, by both banks and supervisors, with much of the focus instead being on capital with the introduction of the Basel II capital framework. The recent turmoil has re-emphasised the importance of liquidity as a key determinant of the resilience of the banking system, and has also highlighted the linkages between funding liquidity risks and market liquidity risks. Some of the areas where there appears to be scope for improvement include: liquidity stress testing practices, to incorporate the implications of wider market disturbances, rather than just firm-specific disturbances; the management of liquidity risks arising from off-balance sheet activities and contingent commitments; and the information provided to supervisors and the market in relation to banks' liquidity risks.

A fourth area being examined is liquidity provision by central banks. A number of central banks have changed the way that they conduct their market operations in an effort to ease persistent strains in their domestic money markets. Within the central banking community, there is an ongoing examination of a number of issues, including: the assets that the central bank is prepared to lend against; with whom it is prepared to deal; on what terms liquidity should be made available; and to what extent the arrangements for day-to-day liquidity operations can also be used for emergency liquidity assistance. On a related issue, in light of the United Kingdom's experience with Northern Rock, policymakers in a range of countries are reconsidering their crisis management arrangements for dealing with a distressed financial institution (see the chapter on *Developments in the Financial System Infrastructure* for a discussion of these issues in Australia's context).

## Box A: Financial Guaranty Insurers (Monolines)

Financial guaranty insurers (FGIs), often called monolines, receive insurance payments from issuers of debt in return for guaranteeing that the holders of that debt receive full payment of interest and principal. The cornerstone of the FGI business model has been their high credit ratings – typically AAA – since this underpins the value of the insurance, or credit protection, provided to investors.

FGIs have existed since the early 1970s, initially focusing on the US municipal bond market. They are still an important source of credit enhancement in this market, insuring around 60 per cent of municipal debt obligations. Over the past decade, however, structured credit products, including securities backed by US sub-prime mortgages, have been an increasingly important source of business for the FGIs. The credit enhancement that they provide has played an important role in making securities based on sub-prime loans attractive to a broad range of investors. FGIs have insured around \$US2½ trillion of total debt that is currently outstanding, with around \$US1.9 trillion of this accounted for by the four major US FGIs, which dominate the global bond insurance industry. Of this, around 1½ per cent is accounted for by sub-prime mortgages and a further 2½ per cent by CDOs partially backed by sub-prime mortgages. (In Australia, FGIs have focused on insurance of corporate bonds, often referred to as credit wrapping.)

Another change over the past decade has been that much more of the insurance of structured finance exposures has been written in the form of credit default swaps (CDS), rather than standard insurance policies. This has made the FGIs' accounting profits more sensitive to market conditions. In particular, US accounting standards require that these CDS are marked-to-market at each balance date. In contrast, accounting standards only require the establishment of loss reserves for standard insurance policies if there is a material deterioration in the credit quality of the reference entity.

One feature of the global financial turmoil has been a marked increase in concerns about the creditworthiness of debt that has been insured by the FGIs even though actual defaults have, to date, been limited. Consequently, while FGIs' provisions have increased slightly, a more significant impact has been through considerable mark-to-market losses on the insurance provided through CDS, which has weakened the capital positions of some monolines. Reflecting this, the share prices of the monolines have declined sharply in recent months (Graph A1). While some monolines have been able to raise new capital to preserve their AAA ratings, others have suffered rating downgrades by at least one of the rating agencies and are finding it difficult to raise significant new capital. The US banks with the largest exposures to monolines have held discussions with the insurers (at the instigation of regulators), though a concrete proposal for a coordinated rescue effort has not emerged.

Internationally, the concern is that the downgrading of monolines has potentially widespread implications for credit markets and the financial sector more generally. Issuers who rely on monolines' credit enhancement to access credit markets will likely face higher funding costs, while investors holding insured debt will likely see the market value of their holdings decline in line with the deterioration in the value of the credit enhancement. A number of banks have already written down the value of credit protection, bought in the form of CDS, from the weakest monolines. Moreover, some investment funds may, depending on their investment mandates, need to sell downgraded bonds in distressed markets – a development that could exacerbate already unsettled debt markets.

In Australia, the effect on bond and other markets of any further downgrades to FGIs is likely to be less pronounced than in a number of other countries, though at least one bank has already announced higher provisions due to the downgrade of a US monoline. The relatively small effect on Australia reflects a number of factors.

First, credit-wrapped bonds account for only a relatively small share of the Australian corporate bond market. As at March 2008, there were \$24 billion of credit-wrapped bonds outstanding, representing just under 7 per cent of all non-government bonds outstanding in the domestic market (Graph A2). Second, structured finance products in Australia rarely use credit wrapping as a form of credit enhancement, with only about one per cent of AAA-rated CDOs having been credit wrapped. Instruments such as RMBS and CDOs instead typically rely on subordination, over-collateralisation, lenders' mortgage insurance and excess spread reserves for credit enhancement. Moreover, the Australian market is made up almost entirely of investment-grade corporates, with the 'pre-wrapping' average rating being BBB+. This suggests that any downgrades to FGIs would not result in a substantial deterioration in the underlying credit quality of domestic bonds. ❧

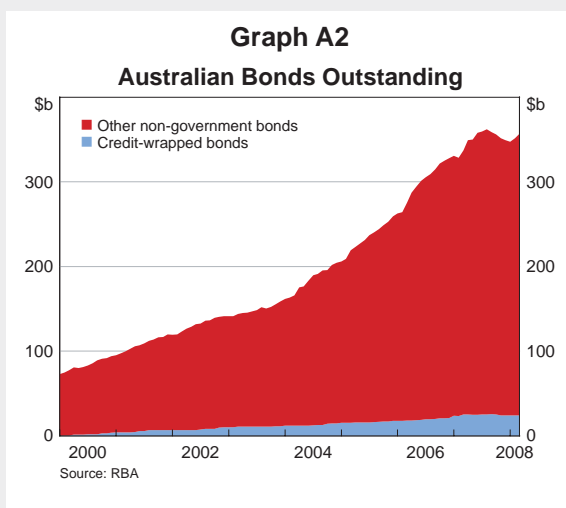
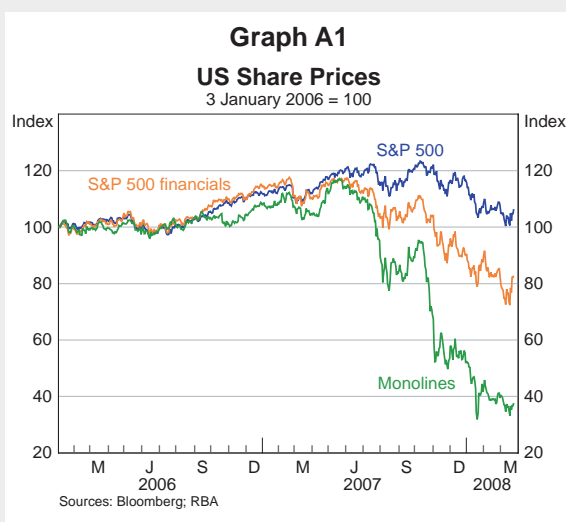

## Box B: The ABX.HE Credit Default Swap Indices

The rapid global growth of credit derivatives markets over recent years has been associated with the introduction of a number of tradeable credit default swap (CDS) indices that track CDS on standardised baskets of reference entities. These indices provide market participants with a way to trade the credit risk of the underlying reference entities without having to enter into multiple CDS. Moreover, because trading in the indices is supported by a group of market makers, liquidity in the CDS index market is typically higher than that in the market for individual CDS, or in the cash market for the underlying reference obligations.

There are currently about a dozen sets of CDS indices being traded, covering various segments of the credit market. One set of indices that has received considerable attention recently, particularly given the problems in the US sub-prime mortgage market, is the ABX.HE indices, which track CDS on US sub-prime residential mortgage-backed securities (RMBS). This Box provides some background on these indices, and then looks at pricing developments during the past year or so.

### How the Index Works

Each ABX.HE index tracks CDS on a fixed sample of 20 RMBS, for which the underlying collateral is predominantly US sub-prime mortgages. There are five sub-indices, each corresponding to a different rating class of the RMBS (Figure B1). For example, the ABX.HE.A index references A-rated tranches of 20 RMBS, while the ABX.HE.BBB index references BBB-rated tranches of the *same* 20 RMBS. Importantly, the tranches referenced by the indices are selected based on their ratings at the time the indices are launched, and are not affected by any subsequent changes to these ratings. This means that over time, the ABX.HE.A index, for example, will not necessarily always reference A-rated tranches.

A new series, or 'roll', of the indices is added every six months based on sub-prime RMBS issued in the six months prior to the roll date. The first series of the index, the '06-1' series, began trading in January 2006 and referenced 20 RMBS issued in the second half of 2005. The introduction of the fifth series of the index, '08-1', was scheduled for January this year, but was postponed because there were not enough RMBS issued in the second half of 2007 that were eligible for inclusion.

The RMBS referenced in each series are selected based on a poll of ABX.HE market makers and tend to be those that have the most liquid CDS markets. To be considered for inclusion in the index, the RMBS must also meet certain criteria, specified in the index rules, relating to their size, the characteristics of their underlying mortgage pools, and their expected lives.

**Figure B1: Composition of the ABX.HE Indices**

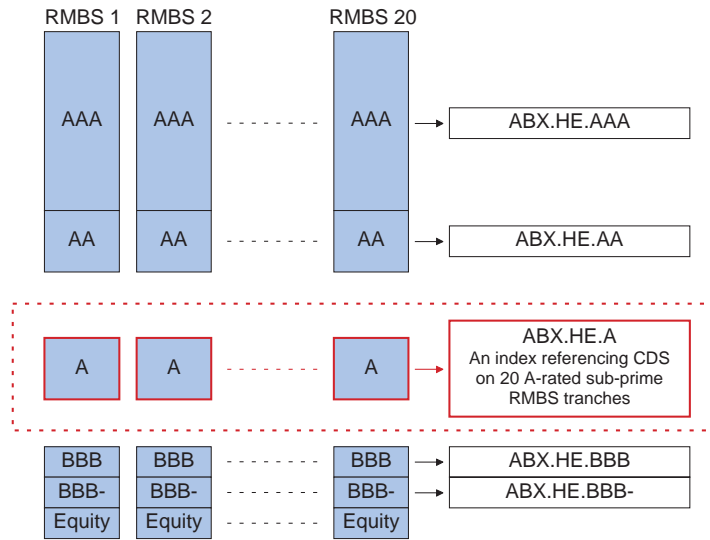

Source: RBA

At their launch, each ABX.HE index contract has a fixed notional amount and the 20 underlying RMBS tranches are equally weighted. As the tranches are paid down or experience write-downs, the notional amount of each index declines proportionately.

As with a CDS, entering into an ABX.HE index contract is analogous to buying or selling insurance on the underlying RMBS tranches. An investor wanting to hedge an existing position, or otherwise establish a short credit position using the index (known as the ‘protection buyer’), is required to pay a monthly premium to the other party (the ‘protection seller’). These premiums are calculated based on the outstanding notional amount of the index and a fixed premium rate, with the premium rate determined at the launch of each ABX.HE index based on an average quote from the market makers. The ABX.HE indices that reference lower-rated RMBS tranches typically carry higher premium rates than those referencing higher-rated tranches due to the higher expected likelihood of default.

In return for the premiums, the protection buyer in an ABX.HE index contract is compensated by the protection seller when any interest or principal shortfalls or write-downs on the underlying mortgages affect the constituent RMBS. Unlike with a conventional CDS, the index contract does not terminate when these credit events occur; rather it continues with a reduced notional amount until maturity. If credit events are subsequently reversed – for example, a principal shortfall is made up – then the protection buyer reimburses the protection seller.

Unlike most other CDS indices, the ABX.HE indices are traded on a price basis, rather than a spread basis. Because the premium rate on each ABX.HE index is fixed at its launch, the market prices of the indices adjust to reflect changes in risk aversion or the market’s assessment

of the default risk on the underlying RMBS. A price below par implies that the market cost of protection has increased since the index was launched. In this case, in addition to the monthly premiums based on the fixed premium rate, someone wanting to buy protection by entering into an ABX.HE contract would have to make a one-off upfront payment to the protection seller. For example, if the price of the index was quoted at 90 per cent of par, then the protection buyer would pay 10 per cent of the index notional amount to the protection seller. By contrast, if the index was quoted at 110 per cent of par, then the protection buyer would receive 10 per cent of the index notional amount from the protection seller, and thereafter pay the premium based on the fixed premium rate.

While the main users of the ABX.HE indices are investors wanting to either hedge, or gain exposure to, the credit risk on US sub-prime mortgages, there is also scope to use the indices for various relative-value trading strategies. For example, an investor that held the view that the A-rated tranches of the sub-prime RMBS would perform better, and the BBB-rated tranches worse, than market prices suggested, could buy protection on the ABX.HE.BBB index while simultaneously selling protection on the ABX.HE.A index. Similarly, it is possible to enter into relative-value trades based on the various vintages of the ABX.HE indices.

## Pricing Developments

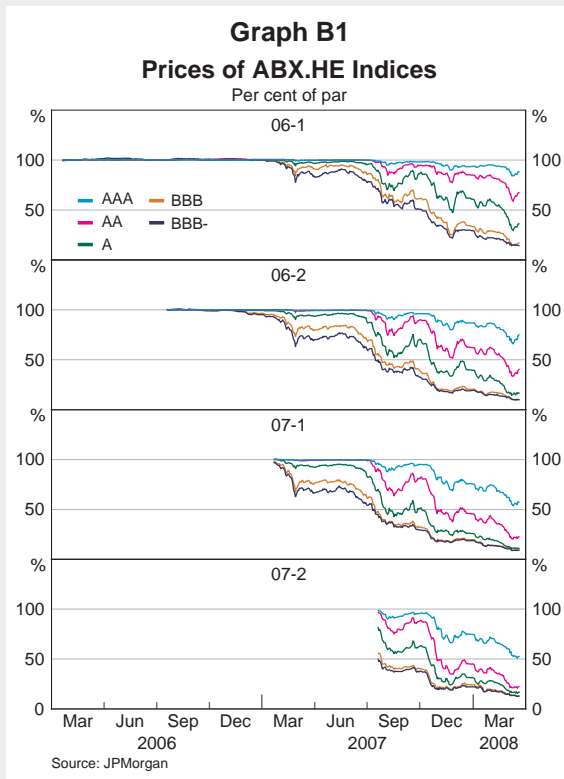

As noted above, there have been four series of the ABX.HE indices launched since January 2006. All of them have recorded considerable price falls since their introduction, associated with the deteriorating conditions in the US sub-prime mortgage market and the general rise in risk aversion (Graph B1). Prices for the 'BBB' and 'BBB-' sub-indices of all the vintages are currently being quoted at around 10–15 per cent of par. This means that someone buying protection would have to pay about 85–90 per cent of the notional amount upfront, in addition to the ongoing premiums. Such a high upfront payment suggests that the market expects a significant loss of principal on the underlying RMBS tranches within a relatively short space of time. The prices of the sub-indices referencing higher-rated tranches of the RMBS have not

fallen by as much, reflecting their greater protection via subordination, although even the ‘AAA’ sub-indices of the two most recent series are currently being quoted below 60 per cent of par.

Comparing vintages, the prices of the newer indices have tended to fall by more than the older indices, consistent with the fact that sub-prime mortgages originated more recently are showing a worse arrears performance (after adjusting for seasoning effects) than those originated earlier. In most cases, the fixed premium rates for the newer indices are also considerably higher than for the older indices (Table B1). In the ‘07-2’ series, the fixed premium rates for the ‘BBB’ and ‘BBB-’ sub-indices both reached 500 basis points, which is the ceiling imposed by the index rules, and consequently, both these indices began trading substantially below par.

To compare the performance of the different vintages across time, the market prices need to be converted into an implied spread, given the change in the fixed premium rates across different series. This can be done using assumptions about the expected duration of the underlying RMBS. Graph B2 shows implied spreads estimated by JPMorgan for the four vintages of the ABX.HE.AAA index. After averaging less than 20 basis points in the first half of 2007, the implied spreads on these indices increased dramatically in the second half of 2007, and have risen further over the past few months. Spreads on the newer vintages of the ABX.HE.AAA index are significantly higher than those on the older vintages, consistent with

the relative performance of the underlying mortgage pools noted earlier. For the ‘07-2’ series, the implied spread has risen to about 1 100 basis points. Implied spreads on the ‘BBB’ and ‘BBB-’ sub-indices are exceptionally high at the moment, in most cases above 10 000 basis points.

In interpreting these movements, it is important to note that the RMBS tranches referenced by these indices are not always at the top of their respective capital structures. For example, the senior part of the capital structure of an RMBS often consists of a number of AAA-rated tranches of varying duration. The tranches referenced in the ABX.HE indices have typically been

**Table B1: ABX.HE Fixed Premium Rates**

Annual, basis points

	Series			
	06-1	06-2	07-1	07-2
ABX.HE.AAA	18	11	9	76
ABX.HE.AA	32	17	15	192
ABX.HE.A	54	44	64	369
ABX.HE.BBB	154	133	224	500
ABX.HE.BBB-	267	242	389	500

Source: Markit

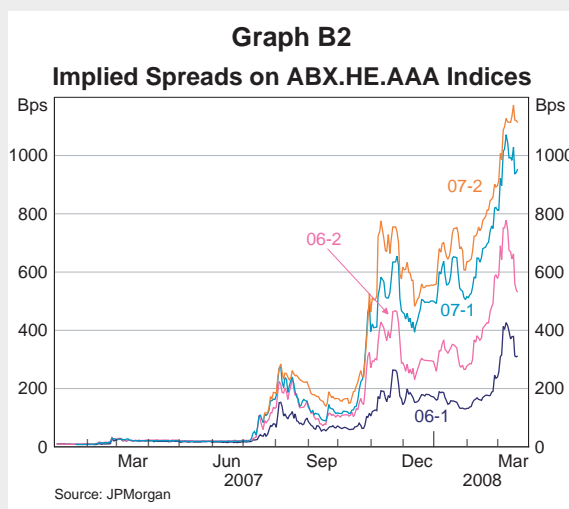

the longer-duration of these, which still benefit from the subordination provided by the more junior classes, but are more risky than the other AAA-rated tranches. This could partly explain why the prices of the 'AAA' sub-indices of the ABX.HE may be at levels that do not appear commensurate with the expected losses on all the AAA-rated classes of the sub-prime RMBS.

The declines in the prices of the ABX.HE indices have been associated with rating downgrades to a number of the constituent RMBS tranches, particularly those that were lower rated to begin with. For example, most of the A, BBB and BBB- tranches referenced by the '07-1' index are now rated CCC or lower, though fewer of the AAA-rated tranches have been downgraded.

Because liquidity in the cash markets for many structured credit products has been quite low, particularly since the onset of the current credit market turbulence, the ABX.HE indices have been one of the few sources of pricing information for sub-prime related securities. As a result, many investors have been using the indices as a reference point for valuing their, often more diverse, holdings of sub-prime related securities. The sharp falls in the prices of the ABX.HE indices over the past year or so have therefore played a part in the large credit write-downs that some financial institutions have recently been reporting.

There is, however, a growing concern that the prices of the ABX.HE indices, particularly the 'AAA' sub-indices, may be giving an unrealistic signal of the losses likely to be sustained on the underlying RMBS, which is prompting some to question the use of these indices in valuation models. According to one estimate, the recent prices of the ABX.HE indices imply cumulative losses of about one third on the constituent RMBS. One way this could occur would be if two thirds of mortgage holders defaulted, and the average recovery rate was only half of the mortgage values. This would be many times worse than historical experience and implies a very significant fall in US house prices. Those questioning the use of ABX.HE indices in valuation models have also focused on the fact that the indices capture only a very narrow slice of the market – 20 underlying RMBS versus the 50–100 that were typical in ABS CDOs produced in recent years – and that the prices may be prone to distortion given the relatively thin trading seen recently. ✎



# The Australian Financial System

The Australian financial system is in sound shape and is weathering the turbulence in financial markets better than the financial systems in many other countries. The largest banks continue to report high levels of profitability, low non-performing loan ratios and strong capital positions. Banks' balance sheets have also continued to expand rapidly, underpinned by strong growth of lending to the business sector.

Against this favourable backdrop, recent developments in global financial markets have posed a number of challenges for the Australian financial system. In particular, while the demand for funding from banks has increased, the cost of financing this demand, in both domestic and offshore markets, has risen significantly. The banking system has been able to provide this additional financing, with deposits growing strongly and banks continuing to be able to raise a significant amount of funding in both domestic and international wholesale markets. The strains in credit markets are, however, having an effect on the nature of competition in the financial system. Most notably, difficulties in the RMBS markets are affecting the institutions that rely heavily on this source of funding to a greater extent than other lenders, and there has been some tightening of credit conditions in the mortgage market. There are also signs that the terms on which finance is available to some segments of the business loan market have tightened, with some foreign financial institutions looking to scale back their business lending in Australia.

## Profits and Capital of the Banking System

Unlike banking systems in a number of other countries, the Australian banking system continues to be highly profitable. The five largest banks recorded an aggregate pre-tax profit of \$27 billion

over the past year, an annual increase of 10½ per cent (Table 1). This represents a pre-tax return on equity of 28 per cent, around the same as for the previous year (Graph 14). Profitability continued to be underpinned by low levels of problem loans, strong balance sheet growth, and rising income from wealth management operations.

### Asset Quality

The ratio of banks' non-performing assets to total assets remains low both by historical and international standards. As at end December 2007, this ratio stood at 0.4 per cent

**Graph 14**  
**Profits before Tax\***  
 Five largest banks\*\*

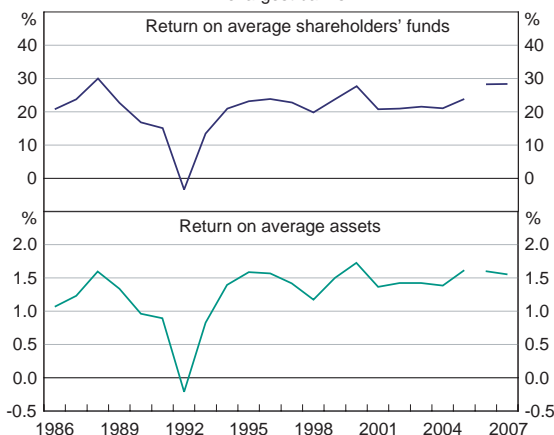

\* 2007 data are year to December for CBA. From 2006, data are on an IFRS basis; prior years are on an AGAAP basis and exclude minority interests from shareholders' funds.

\*\* Four largest banks only prior to 1993.  
 Sources: Banks' annual and interim reports

**Table 1: Banks' Annual Profit Results<sup>(a)</sup>**

Consolidated, five largest banks

	2006 \$b	2007 \$b	Growth Per cent	Per cent of average assets
<b>Income</b>				
Net interest income	30.0	33.0	9.9	1.9
Net income from wealth management	6.0	7.0	17.6	0.4
Other non-interest income	14.7	15.0	1.5	0.9
<b>Expenses</b>				
Operating expenses	24.2	25.2	4.2	1.4
Bad and doubtful debts	1.9	2.6	33.7	0.1
<b>Profit<sup>(b)</sup></b>				
Net profit before tax	24.6	27.2	10.5	1.6
Net profit after tax	17.2	19.1	11.5	1.1

(a) Year to September for ANZ Banking Group, National Australia Bank, St George Bank and Westpac Banking Corporation; year to December for Commonwealth Bank of Australia

(b) Before outside equity interests

Sources: Banks' annual and interim reports

of banks' total assets, down slightly on the figure six months earlier (Graph 15). Of these non-performing assets, just under half are classified as 'impaired', in that repayments are in arrears by

**Graph 15**

**Banks' Non-performing Assets**

Consolidated, per cent of on-balance sheet assets

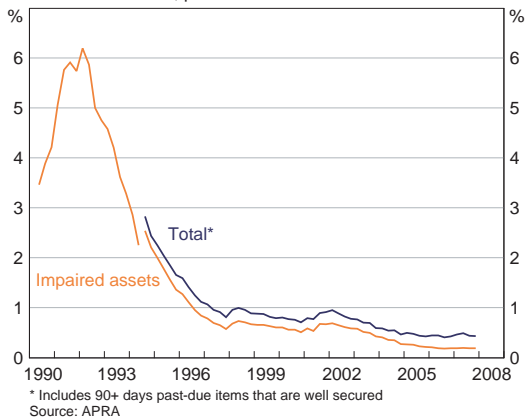

more than 90 days (or are otherwise doubtful) *and* the debt is not well covered by the value of collateral. The remainder, while in arrears, are considered to be well covered by collateral. Despite the recent small decline in non-performing assets as a share of total assets, charges for bad and doubtful debts increased by one third over the past year, albeit from a very low base, to be the equivalent of 0.2 per cent of outstanding loans (Graph 16).

Australian banks have reported that they have only limited direct exposure to the sub-prime problems in the United States, primarily

through small holdings of financial instruments backed by sub-prime debt. Some also, however, have indirect exposures through their links to institutions and businesses that have been directly affected by recent events. As discussed in Box A, one example is through the decline in the value of credit protection provided by US 'monoline' bond insurers. Another is through exposures to companies that had relied heavily on short-term debt for financing and have found this debt difficult to roll over in the current environment. Reflecting this, some of the larger banks

have recently announced provisions against some of these exposures.

The recent decline in the aggregate non-performing loan ratio is evident across each of the main segments of banks' domestic loan portfolios (Graph 17). In the business portfolio, the ratio of non-performing loans to total loans stood at 0.9 per cent as at December 2007, compared with 1.3 per cent four years earlier. Within this aggregate figure, the share of banks' commercial property lending that is classified as impaired picked up slightly over the year to September 2007 (the latest available data), to 0.3 per cent, although this too remains low by previous standards (Graph 18). As noted above, some banks have recently announced higher provisions against business exposures, though the increase remains small compared with the size of the aggregate business loan portfolio. That said, any slowing in the domestic economy would likely be associated with some decline in the average quality of the business loan portfolio.

In the housing portfolio, 0.3 per cent of loans on banks' domestic balance sheets were non-performing as at December 2007, down from the figure in mid year and about the same as a year ago. Most non-performing housing loans are considered by banks to be well covered by the value of collateral. The ratio of non-performing personal loans to outstandings has also fallen slightly over the past six months and, at 0.9 per cent, is around the same level as a year ago. As noted in the

**Graph 16**

**Charge for Bad and Doubtful Debts\***  
Per cent of outstanding loans, five largest banks\*\*

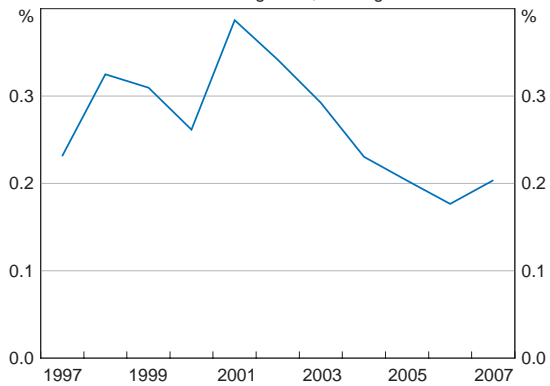

\* 2007 data are year to December for CBA. From 2006, data are on an IFRS basis; prior years are on an AGAAP basis.  
\*\* Net of provisions.  
Sources: Banks' annual and interim reports

**Graph 17**

**Banks' Non-performing Loans\***

Domestic banks, per cent of outstandings by loan type

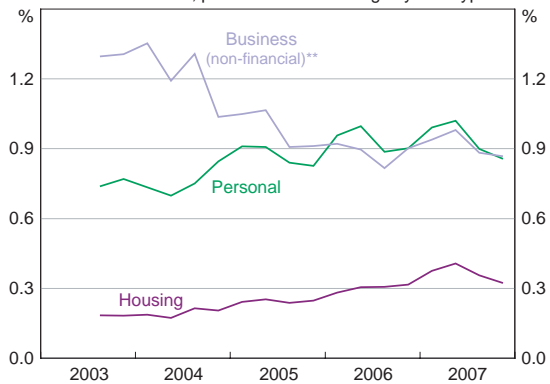

\* Includes 90+ days past-due items that are well secured  
\*\* Includes bill financing  
Source: APRA

**Graph 18**

**Banks' Commercial Property Impaired Assets**

Consolidated, per cent of outstandings by loan type

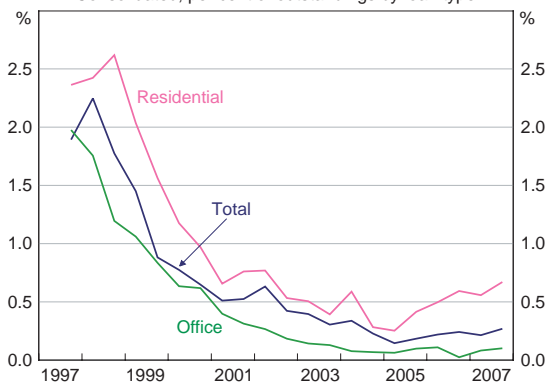

Source: APRA

*Household and Business Balance Sheets* chapter, this pattern has been broadly similar for credit cards and other personal loans.

The low arrears rate on household loans relative to many other countries – and particularly the United States – reflects the ongoing strength of the Australian economy, as well as a number of other inter-related factors. One of these is that the non-conforming housing loan market in Australia (the closest equivalent to the sub-prime market in the United States) accounts for less than one per cent of outstanding mortgages, compared with about 13 per cent in the United States, and Australian banks have been very minor participants in this market. Another is that the level of interest rates has been quite different in the United States and Australia; in the United States, the Federal funds rate fell to 1 per cent in 2003/04 and then rose only slowly, making it possible for many borrowers with poor credit histories and limited repayment ability to obtain loans. A third factor is the legal environment. The Australian Uniform Consumer Credit Code (which has been in operation since 1996) means that courts can set aside mortgage agreements where the lender could reasonably have known that the borrower would not be able to repay the loan without substantial hardship. Further, Australian mortgages are ‘full recourse’, so that unlike in a number of states in the United States, a borrower in distress cannot just hand the keys to the lender, and effectively extinguish the debt. These legal requirements reduce both the incentive of lenders to provide loans to people that are likely to have difficulty repaying, and the incentive for borrowers to take out loans that cannot be repaid unless house prices increase substantially.

While these various factors have helped promote a more soundly based mortgage market in Australia, there nonetheless had been a general loosening of credit standards over recent years. For example, the share of low-doc loans among all housing loans extended in 2006 was 10 per cent, compared with 3 per cent in 2002. In addition, the debt-servicing criteria that lenders use in assessing loan applications had been eased, and lenders began making greater use of lower-cost electronic and off-site property valuation techniques. These changes mean that, looking forward, for any given state of the economy and interest rates, housing loan arrears are likely to be higher than in the past.

## **Balance Sheet Growth**

The aggregate balance sheet of the banking system has continued to grow strongly over the past six months, reflecting robust demand for credit, particularly from businesses, and the provision of credit to some borrowers that in previous years would have obtained financing in the capital markets.

The assets held on banks’ domestic balance sheets increased at an annualised rate of 31 per cent over the six months to January 2008, to stand at around \$2 200 billion, following (annualised) growth of 20 per cent over the previous six months (Table 2). In the recent period, balance sheet growth has been inflated somewhat by banks issuing a significant amount of short-term paper to other banks as part of their liquidity management – banks’ holdings of securities issued by other ADIs are currently around \$84 billion, or 56 per cent, higher than they were in July 2007, with the vast bulk of this increase accounted for by securities with a maturity of less than one year (see below). Excluding these issues, as well as intra-group activities, total assets still increased at an annual rate of 22 per cent over the past six months. The increase

**Table 2: Banks' On-balance Sheet Assets**

Domestic books

	Level		Change
	January 2008	July 2007	July 2007 – January 2008
	\$b	\$b	\$b
Liquid assets and marketable securities	376.4	288.0	88.4
<i>Of which:</i>			
Cash and deposits with other banks	77.9	76.6	1.3
Australian ADI securities	234.8	150.9	83.9
Loans and advances	1533.9	1360.8	173.0
<i>Of which:</i>			
Business credit <sup>(a)</sup>	599.3	515.3	84.0
Household credit <sup>(b)</sup>	779.8	717.4	62.3
Intra-group	140.0	115.2	24.8
Other domestic assets	125.9	120.5	5.4
<b>Total domestic assets</b>	<b>2036.1</b>	<b>1769.2</b>	<b>266.8</b>
Offshore assets <sup>(c)</sup>	159.7	149.0	10.7
<b>Total assets</b>	<b>2195.8</b>	<b>1918.2</b>	<b>277.6</b>

(a) Includes bill financing and some securities holdings  
 (b) Does not include loans that have been securitised  
 (c) Includes amounts due from overseas operations  
 Sources: APRA; RBA

in aggregate assets also partly reflects the bringing on-balance sheet of liquidity facilities to conduit vehicles that had previously been funded in the asset-backed commercial paper market, although the extent of this has been less than in some other banking systems.

Notwithstanding these factors, the recent expansion of the aggregate balance sheet of the banking system has been underpinned by strong growth of lending to the domestic business sector, with bank business credit outstanding increasing at an annualised rate of around 30 per cent over the six months to January 2008 (Graph 19). Loans with a value greater than \$2 million, which comprise nearly 70 per cent of business credit outstanding, accounted for much of the pick-up in growth over the second half of 2007. This is consistent with a reintermediation of business credit as corporates have found it more difficult to access non-intermediated debt markets since the onset of the current turmoil. In contrast, household credit growth (including

**Graph 19**

**Bank Credit\***

Six-month-ended annualised percentage change

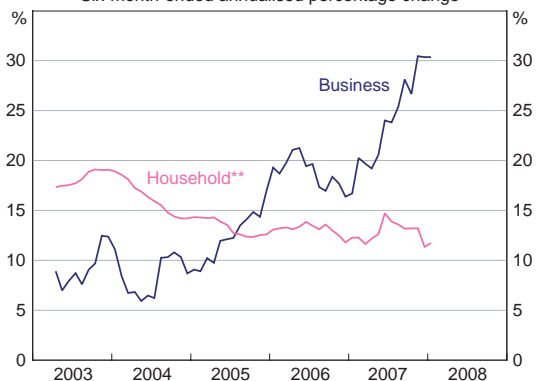

\* Adjusted for some series breaks  
 \*\* Including securitisation  
 Source: RBA

loans no longer held on the balance sheet because they have been securitised) has moderated to an annualised rate of just under 12 per cent over the six months to January, compared to a peak of nearly 20 per cent in late 2003. The funding of this strong balance sheet growth is discussed below.

The assets of foreign-owned banks, as a group, had been growing at an above-average rate prior to the onset of the credit market turbulence, reflecting the strength of their business lending over the past couple of years and also attempts to gain a greater share of the retail market.<sup>1</sup> In the early months of the current turmoil, the combined balance sheets of the foreign-owned banks grew even more strongly, with total assets (excluding intra-group transactions) around 20 per cent higher in September than in June (Graph 20). The pick-up in growth over this period mainly reflected increased holdings of trading securities, which is consistent with reports that some

**Graph 20**

**Assets by Bank Type\***

Domestic books, January 2007 = 100

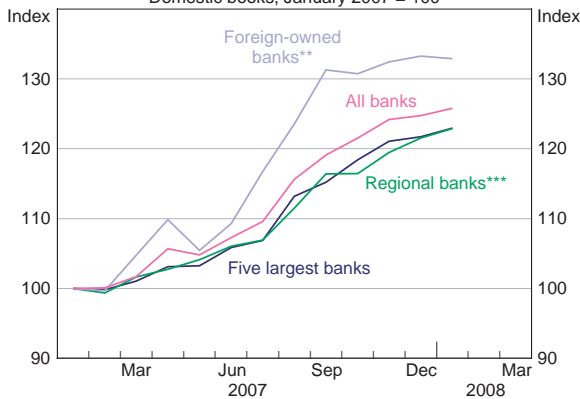

\* Excludes intra-group assets and equity investments in related entities  
 \*\* Adjusted for bank entries and exits  
 \*\*\* Adelaide Bank, Bank of Queensland, Bendigo Bank and Suncorp-Metway  
 Source: APRA

foreign-owned banks had provided liquidity to conduits by purchasing the paper issued by these vehicles. In more recent months, the aggregate balance sheet of these banks has been broadly unchanged, though this has been due to reduced holdings of securities while, on average, lending growth has remained robust. Some foreign banks have, however, recently announced their intention to scale back their operations in Australia. In aggregate, the assets of Australian-owned banks have continued to expand strongly in recent months.

Compared with the growth in domestic balance sheets, growth in the global consolidated assets of Australian-owned banks has been somewhat slower, partly reflecting a moderation in the growth of banks' offshore assets. Over the six months to December 2007, total foreign claims increased at an annualised rate of around 5 per cent, to stand at \$487 billion, which is equivalent to 27 per cent of banks' total assets (Table 3). A large share of these claims, around 46 per cent, is on entities in New Zealand and mainly arise through the activities of Australian banks' local subsidiaries. Like the Australian economy, the New Zealand economy has grown strongly for a number of years and household and business balance sheets generally remain in sound shape.

Uncertainty about the prospects for the US economy has focused attention on the size and credit quality of banks' exposures to the United States. In aggregate, Australian-owned banks have a relatively small direct exposure to the United States, amounting to \$45 billion as at December 2007. This is equivalent to less than 10 per cent of their total foreign exposures and

<sup>1</sup> See Reserve Bank of Australia (2007), 'Box C: Foreign-owned Banks in Australia', Financial Stability Review, March.

**Table 3: Australian-owned Banks' Foreign Exposures**

December 2007, ultimate risk basis

	Level \$b	Share of total Per cent	Six-month-ended annualised percentage change	
			June 2007	December 2007
			Per cent	Per cent
New Zealand	222.1	45.6	10.9	9.5
United Kingdom	118.0	24.2	18.7	2.6
United States	45.1	9.3	22.8	-12.8
Other developed countries	66.9	13.7	37.5	8.2
Other <sup>(a)</sup>	35.3	7.3	28.3	1.4
<b>Total</b>	<b>487.5</b>	<b>100.0</b>	<b>18.4</b>	<b>4.7</b>
<i>Memo: Per cent of total assets</i>	<i>27.0</i>			

(a) Includes developing countries and offshore centres  
Source: APRA

only 2½ per cent of their total assets. Moreover, these exposures typically do not arise through direct lending to the US household sector. Consistent with this, and as noted above, Australian banks' exposures to the US sub-prime mortgage market problems are small, and mainly indirect, through channels such as lines of credit to funding vehicles and lending to some companies that have been affected by credit market conditions.

## Income

Over the past decade, the contribution of strong lending to growth in banks' net interest income has been partly offset by an ongoing decline in the interest rate margins that banks earn on this lending. Over the past year, the ratio of net interest income to average interest-earning assets of the five largest banks fell by a further 8 basis points, to stand at 2.2 per cent, compared to 3.4 per cent a decade ago (Graph 21). With most banks having only reported results for the year ended September 2007, the impact of the recent turbulence in credit markets is yet to be fully reflected in these figures. It is likely that margins have remained under downward pressure in more recent quarters as a result of higher funding costs, though this will be at least partly offset by recent increases in interest rates on both household and business loans.

**Graph 21**

### Net Interest Income\*

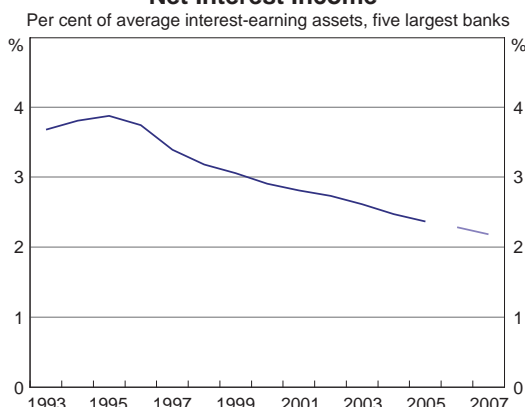

\* 2007 data are year to December for CBA. From 2006, data are on an IFRS basis; prior years are on an AGAAP basis.  
Sources: Banks' annual and interim reports

Banks' income has also been supported by strong growth in wealth management income, which increased by 18 per cent over the past year, to account for 13 per cent of the five largest banks' total income. Unlike some of the large globally active banks, Australian banks have not traditionally relied heavily on income from trading activities. This form of income accounted for only around 5 per cent of the five largest banks' total income in 2007, with this share having been relatively stable over the past five years. Consistent with this, Australian banks have only small unhedged positions in financial markets.

**Graph 22**  
**Banks' Costs and Income\***  
Five largest banks

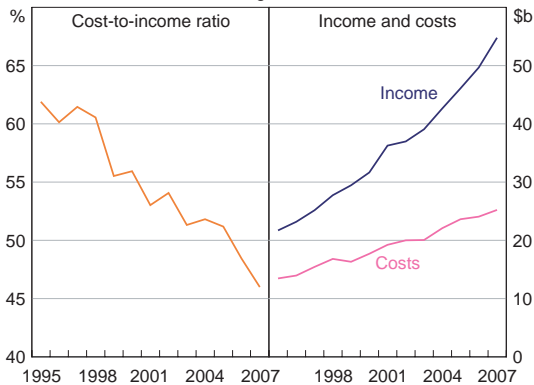

\* Excluding significant items. 2007 data are year to December for CBA.  
From 2006, data are on an IFRS basis; prior years are on an AGAAP basis.  
Sources: Banks' annual and interim reports; RBA

**Graph 23**  
**Banks' Capital Ratios\***  
Consolidated, locally incorporated banks

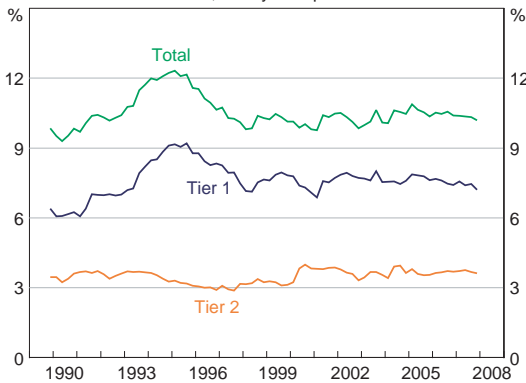

\* Per cent of risk-weighted assets  
Source: APRA

Over the past year, the five largest banks' operating expenses increased by 4.2 per cent – considerably slower than growth in income and assets – and as a result the cost-to-income ratio (excluding significant items) fell by around 2 percentage points, to 46 per cent (Graph 22).

### Capital Adequacy

Australian banks remain well capitalised, with an aggregate Tier 1 capital ratio of 7.2 per cent and a total capital ratio of 10.2 per cent as at December 2007 (Graph 23). The aggregate capital ratio has declined slightly over the past year, reflecting the strong growth in assets over the second half of 2007, although it remains around its average of the past decade. Credit unions and building societies also remain well capitalised, with aggregate capital ratios of around 16 per cent and 13 per cent, respectively.

Banks' strong profitability has meant that retained earnings have been an important source of Tier 1 capital over recent years, although a rising share of Tier 1 capital has been accounted for by 'innovative capital instruments', such as hybrid

securities. Nonetheless, paid-up capital, which accounts for the majority of banks' Tier 1 capital, has continued to grow over the past six months due to acquisitions and the dividend reinvestment plans of the five largest banks.



As discussed in the *Developments in the Financial System Infrastructure* chapter, the Basel II Capital Framework was introduced by APRA on 1 January 2008. The introduction of Basel II is not expected to have a significant effect on the aggregate capital ratio, though some banks have indicated that it may result in a slight increase in their measured ratios.

## Funding Conditions and Financial Markets

### Funding Conditions

Notwithstanding their strong profitability, low non-performing loan ratios and sound capital positions, banks have faced more challenging conditions in credit markets over the past six months than they have for some time. Nevertheless, they have continued to be able to tap both domestic and international markets to finance the strong growth in their assets, although this has been at significantly higher spreads than has been the case over recent years. New fund raisings have also, on average, tended to be for shorter maturities than previously, with investors globally demanding very high premia for term funding.

Banks' domestic short-term funding costs have risen significantly since August, with the spread between the yield on three-month bank bills and the overnight index swap rate for the same maturity averaging 58 basis points over the past month, and currently standing at 45 basis points (Graph 24). This compares with an average spread of

10 basis points in recent years. Movements in this spread over the past six months have followed the same general pattern as similar spreads in a number of overseas markets, although the increases seen in September and December were somewhat smaller in Australia than elsewhere.

The cost of issuing in domestic term markets is also substantially higher than it was in the first half of 2007. For example, the two- and three-year bonds issued by some of the largest banks in recent months were at spreads of nearly 50 basis points above the bank bill swap rate (which itself has increased significantly), compared to around 30 basis points in September 2007, and an average of 10 basis points prior to the disturbances in credit markets. As discussed further below, offshore bond issuance has been very strong in the past few months, with spreads also widening considerably. Much of the activity has been in the US market, with the effective Australian dollar cost of issuing one- to two-year bonds being up to 40 basis points above the equivalent swap rate for 'vanilla' bonds, and slightly less than that for extendible bonds (Graph 25).

The funding demands of the banking system have been exacerbated by difficulties in both the asset-backed commercial paper (ABCP) market and the residential mortgage-backed securities

**Graph 24**

**3-month Bank Bill Rate  
Spread to OIS**

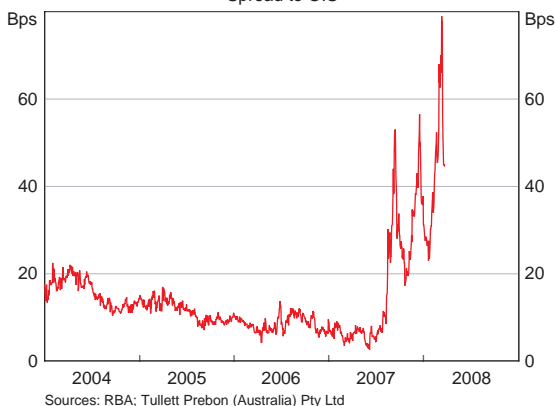

**Graph 25**

**US\$ Bond Pricing at Issuance\***

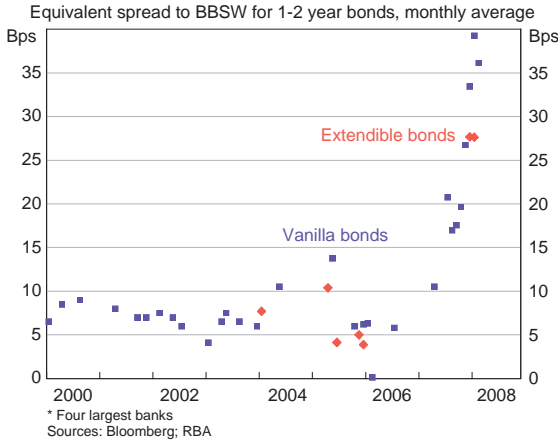

**Graph 26**

**Australian ABCP Outstanding**

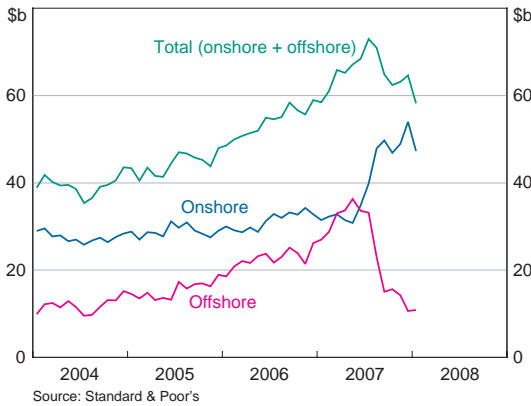

**Graph 27**

**RMBS Issuance**

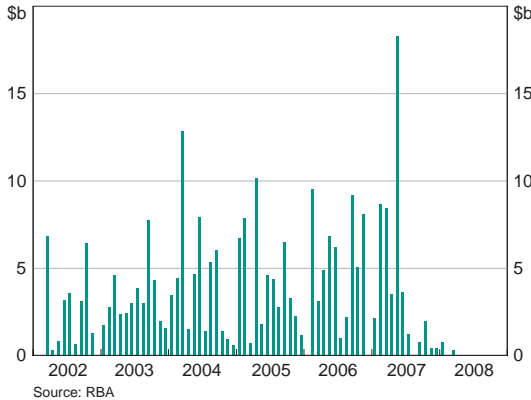

(RMBS) market. The disruption to the offshore ABCP market has been particularly notable, with this market largely closed to new issues; as at January 2008, the outstanding value of offshore ABCP issued by Australian entities was 70 per cent below its peak in May 2007 (Graph 26). The domestic market has been able to fill some, but not all, of the shortfall, with onshore issuance of ABCP increasing significantly over the second half of 2007. Reflecting these developments, between July 2007 and January 2008, total outstanding ABCP fell by around \$15 billion, or 20 per cent.

The spread on ABCP over the bank bill rate – which, as noted above, has itself increased – has risen significantly; prior to mid 2007, it had been possible to issue ABCP in Australia at a spread of less than 5 basis points over the bank bill rate, compared with current spreads of around 50 basis points. These difficulties in the ABCP market have seen the conduits that issue ABCP draw on their contracted liquidity facilities with banks. Some banks have also purchased the ABCP of the conduits that they sponsor as an alternative to providing a loan.

Conditions in the RMBS market have been more difficult still. Over recent months, issuance of RMBS has been extremely limited, after very strong growth in previous years. Since July last year, issuance has totalled less than \$6 billion, compared with \$45 billion in the first half of 2007 (Graph 27). The

issues that did take place in late 2007 were at spreads of 40 to 60 basis points over the bank bill swap rate, compared to spreads of around 15 basis points earlier in 2007, with industry liaison suggesting that the required spreads have increased significantly further over recent months. With the bank bill spread itself having increased, the interest rate on a new AAA-rated RMBS would be likely to be over 150 to 200 basis points above the cash rate, compared with an average of 25 basis points over recent years.

These significantly higher spreads have meant that lenders that rely on the securitisation market have curtailed their lending and/or are continuing to rely on warehouse facilities provided by banks. While the cost of these facilities has also risen significantly, the increase has not been as large as the rise in RMBS spreads. Lenders are clearly reluctant to issue RMBS at current spreads, given that doing so would mean that their mortgage business would be unprofitable at existing mortgage rates.

Despite the disruptions to securitisation markets, banks, in aggregate, have been able to raise sufficient funds in domestic and offshore wholesale markets and through deposits from the household and business sectors (Table 4). Indeed, a number of banks have reported that they are ahead of their planned funding schedules for the current financial year.

**Table 4: Banks' Liabilities**

Domestic books

	Level		Change
	January 2008	July 2007	July 2007 – January 2008
	\$b	\$b	\$b
Deposits	836.9	759.3	77.6
<i>Of which:</i>			
Household	335.9	307.5	28.4
Business	268.8	248.7	20.1
Intra-group	90.8	61.4	29.4
Domestic wholesale <sup>(a)</sup>	697.4	558.7	138.8
<b>Total domestic liabilities</b>	<b>1534.4</b>	<b>1318.0</b>	<b>216.4</b>
Offshore liabilities	536.9	485.8	51.1
<i>Of which:</i>			
Intra-group	92.2	67.4	24.8
<b>Total liabilities</b>	<b>2071.3</b>	<b>1803.0</b>	<b>267.5</b>

(a) Includes short-term paper issued to other banks, and 'other' liabilities

Sources: APRA; RBA

When the strains in credit markets first emerged in August last year, banks significantly increased their issuance of short-term domestic securities, with available data showing that the outstanding value of banks' securities with a maturity of less than one year increased by \$131 billion over the second half of 2007. Around \$50 billion of this increase was accounted for by issuance to the non-bank sector, with investors having a strong preference for short-term bank debt, rather than RMBS and other instruments; the value of non-bank holdings of these securities doubled over the second half of 2007, to around \$100 billion (Graph 28).

**Graph 28**

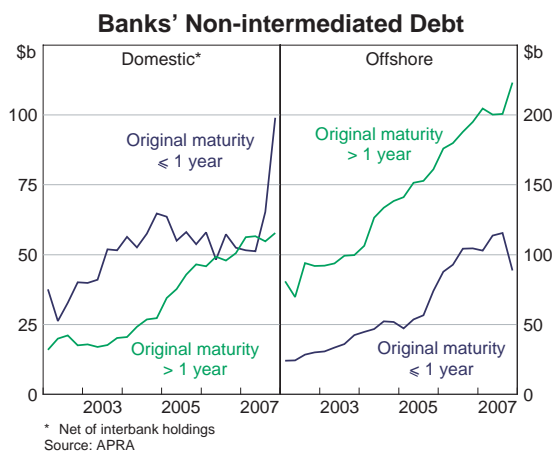

**Graph 29**

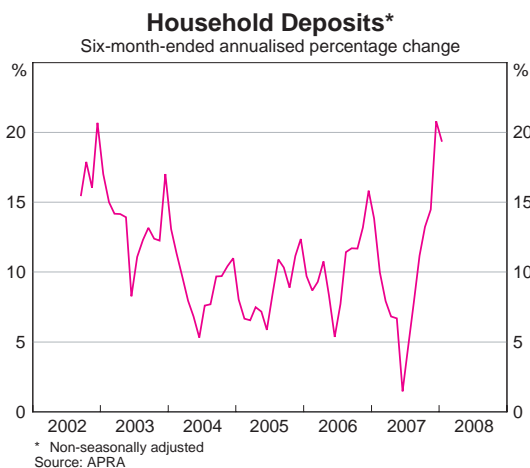

As noted above, banks also issued a significant volume of short-term securities to one another, with the value of banks' holdings of other banks' short-term securities increasing to \$209 billion by the end of 2007, compared with \$126 billion six months earlier. While this did not constitute financing for the banking system as a whole, it did increase the supply of eligible securities that can be used for repurchase agreements with the Reserve Bank, thereby adding to potential liquidity.

Banks have also benefited from strong growth in deposits from households and non-financial businesses, which together increased by \$49 billion over the past six months. Household deposits grew at an annualised rate of around 20 per cent over the six months to January, the fastest pace for a number of years (Graph 29). This strong growth may well continue, given the recent volatility of alternative investments; the March 2008 Westpac and Melbourne Institute Survey of Consumer Sentiment showed that nearly one quarter of surveyed households viewed bank deposits as

the 'wisest place for savings', up from about 11 per cent at the end of the 1990s and the highest share since 1992. Over recent times, the attractiveness of deposits has also been increased by the wide availability of high-yield internet-based accounts and the strong competition in deposit markets as banks seek deposit funding, rather than funding in the capital markets.

The large increase in short-term (domestic) funding has meant that the banking system as a whole is undertaking more maturity transformation than it had previously. While the banks have been prepared to do this, particularly given the significantly higher cost of term funding, they have seen a need to continue to issue in the term funding markets as it has become increasingly apparent that the current repricing of risk is likely to be both more sustained and pronounced than many had originally anticipated.

Reflecting this, the banks have issued record amounts of bonds in offshore markets in recent months. As at December 2007, the value of banks' offshore debt securities outstanding with

a term-to-maturity greater than one year stood at \$223 billion and, so far in 2008, the five largest banks have issued a further \$35 billion of bonds in overseas markets (Graph 30). A significant share of this recent issuance has been in the form of extendible bonds issued in the United States through private placements, rather than public issues. These bonds typically give investors the option of extending the bond's maturity beyond an initial 13 months, until a final maturity date (usually in five to six years).

Each of the four largest banks has also recently tapped the Japanese wholesale market by issuing yen-denominated 'samurai' bonds for the first time. These bonds have typically been at longer terms to maturity than those issued in the United States.

Reflecting the pattern of recent issuance, and assuming no extension, the average term-to-maturity of bank bonds issued so far this year has been around two years, compared with around 4½ years prior to the recent disturbances. However, the average maturity of total outstanding bonds has only declined slightly.

In the current environment, banks also appear to be taking a more cautious approach to their liquidity, with banks currently holding higher levels of liquid assets than they have in recent years. These assets include cash, deposits, and marketable securities such as Commonwealth Government Securities and securities issued by other ADIs (including bank paper issued by other banks). Banks' holdings of these assets have increased to around 17 per cent of total domestic assets in recent months, after this share averaged around 14 per cent over the preceding few years. In addition, a number of banks have recently securitised a portion of their home loan portfolios and kept the resulting securities on their balance sheets. These 'self securitisations' – which provide an additional source of liquidity, particularly when market conditions are difficult – follow the widening of the list of eligible securities for RBA repurchase agreements in September last year to include top-rated RMBS and ABCP backed by prime, domestic full-doc loans, as well as a broader range of securities issued by ADIs.

## Financial Markets

Heightened volatility has been a feature of many financial markets since the previous *Review*. One example is that the daily movement in share prices has averaged around 2 per cent in 2008, compared with 0.9 per cent in the first half of 2007. Overall, the share market is down by around 25 per cent since its peak in November 2007, and by around 13 per cent on its level a year ago.

The share prices of Australian commercial banks have underperformed the broader market over this period, having fallen by around 30 per cent since their peak in November. Despite

**Graph 30**  
**Australian Banks' Offshore Bond Issuance\***  
 A\$ equivalent, quarterly

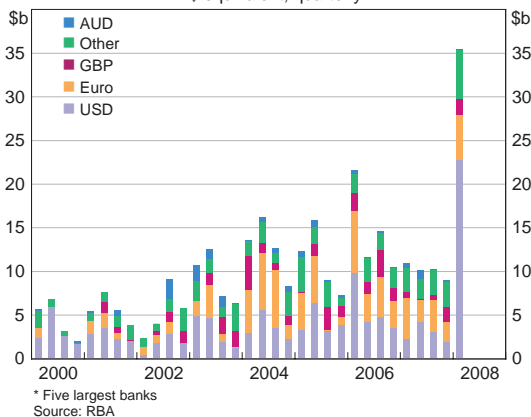

**Graph 31**

**Financial Share Prices**

29 June 2007 = 100

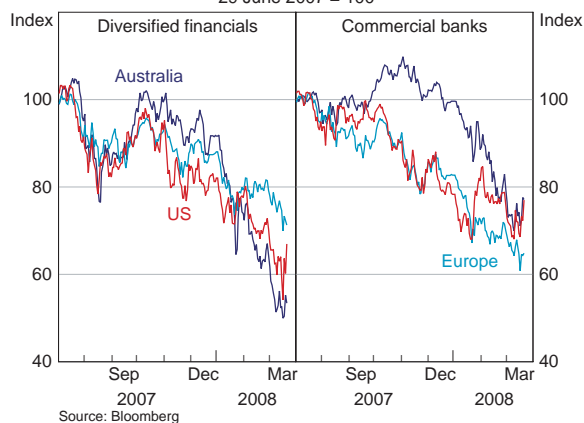

the strong position of the Australian banking system, this fall is broadly similar to the falls in share prices of US and European commercial banks since their peaks (Graph 31). The falls in the share prices of Australian 'diversified financials', some of which focus on investment banking activities, have been sharper still, with the relevant index having declined by around 47 per cent since November, underperforming similar indices in both the United States and Europe. Notwithstanding these recent movements, equity market analysts have maintained their positive outlook for Australian

financials' earnings, forecasting an 8 per cent increase in earnings in 2008/09.

Credit default swap premia for Australian banks have also risen markedly during the current episode. The average price paid for insuring against a default by the largest banks has risen to around \$120 per \$10 000, from around \$10 per \$10 000 for much of the past few years (Graph 5 in *The Global Financial Environment* chapter). While this rise is likely to mainly reflect an increase in investor risk aversion rather than a significant reassessment of the likelihood of an Australian bank defaulting, it is nonetheless broadly in line with that for European banks. The overall impression created by the relatively strong correlation between movements in the various market prices in Australia and overseas is that investors are not being particularly discriminating among banks around the world.

Credit rating agencies continue to view the Australian banking sector favourably (Table 5). Unlike some of their US and European counterparts, rating agencies have not downgraded any of the Australian banks' ratings since the beginning of the market turmoil mid last year, although one small bank was recently placed on a negative credit watch by Standard & Poor's. The four largest banks all have AA ratings from Standard & Poor's, after being upgraded in early 2007.

Overall, Australia's financial market infrastructure has effectively handled the increased volatility and turnover of recent months. The equity market, in particular, has seen extremely large trading volumes on a number of days in recent months (Graph 32). There have also been periods of very high turnover in foreign exchange markets in recent months, and foreign exchange transaction settlements have roughly doubled over the past year, with the inter-bank payments system coping well with the increased volume.

Activity on the Sydney Futures Exchange (SFE) has also trended up over the past year, although not to the same extent as on the equity market. The total value of margins held for SFE derivatives peaked at around \$4.5 billion in June 2007, but trading positions have since been wound back in response to increased market volatility (Graph 33). In August 2007 there were a

**Table 5: Long-term Ratings of Australian Banks**

As at 25 March 2008

	Current	Last change		Date
		Direction		
Adelaide Bank	BBB+	↑		October 2004
AMP Bank	A-	↑		August 2004
ANZ Banking Group	AA	↑		February 2007
Arab Bank Australia	A-	–		January 2007
Bank of Queensland	BBB+	↑		April 2005
BankWest	AA-	↑		August 2006
Bendigo Bank	BBB+	↑		February 2005
Commonwealth Bank of Australia	AA	↑		February 2007
Elders Rural Bank	BBB	↑		August 2007
HSBC Bank Australia	AA	↑		July 2006
ING Bank (Australia)	AA	↑		August 2005
Macquarie Bank	A	–		November 1994
Members Equity Bank	BBB	↑		August 2006
National Australia Bank	AA	↑		February 2007
St George Bank	A+	↑		January 2006
Suncorp-Metway	A+	↑		March 2007
Westpac Banking Corporation	AA	↑		February 2007

Source: Standard & Poor's

number of days of particularly large market movements, which resulted in very large amounts of variation margins having to be paid. In more recent months, market participants' reduced risk appetite has meant that, despite further periods of sharp volatility, total variation margin amounts have been more contained. The increased market volatility has also resulted in SFE increasing margin parameters for SPI futures positions.

Although the market infrastructure has generally

performed well, in late January the equities brokerage firm Tricom was unable to meet its ASX settlement obligations, leading to a 4½ hour delay in settlement. While the delay was disruptive to market participants, and dented market sentiment, the financial position of ASX's clearing house was not compromised, and settlement of participants' and clients' on-market trades (which comprise the bulk of share market activity) was not at risk. The Reserve Bank is satisfied that ASX and SFE clearing and settlement facilities operate in accordance with the Financial Stability Standards determined by the Payments System Board; its most recent assessment of

**Graph 32**

**ASX Trading Volume**

Number of shares traded, 5-day moving average

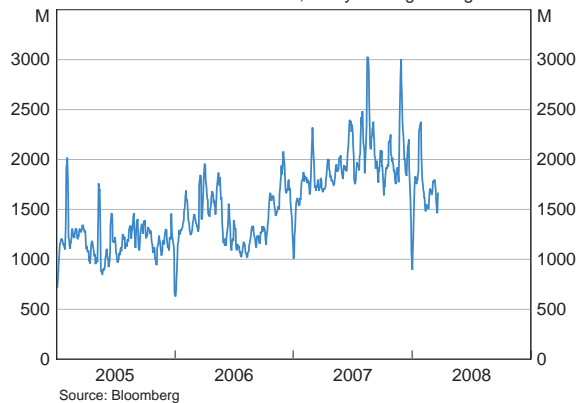

**Graph 33**  
**SFE Margin Amounts**

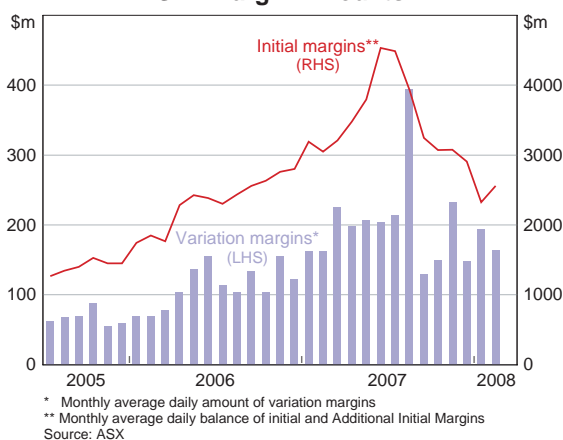

markets for funding (such as mortgage originators and some smaller ADIs) have lost market share, and in the business loan market there are signs that financing conditions have tightened in the high-value end of the market.

Over recent years, strong competition has been a feature of the Australian mortgage market and has led to a marked contraction of margins and, as noted above, a number of changes in lending practices. As discussed in previous *Reviews*, this competition has resulted in the majority of new borrowers paying an interest rate less than the major banks' standard variable indicator rate. In recent years, 'discounts' of at least 70 basis points have been common. The contraction in margins on low-doc loans had been even more pronounced prior to the recent turmoil, with many lenders ceasing to charge a premium on these loans, whereas earlier in the decade an interest rate premium was common. Reflecting this, the average rate paid on new low-doc loans was only around 30 basis points higher than that paid on new full-doc loans as at the end of 2006, compared with 110 basis points earlier in the decade.

The narrowing of spreads on RMBS over the four or so years prior to mid 2007 was an important factor underpinning competition in the mortgage market, as it allowed lenders that rely on this market for funding to offer lower interest rates to borrowers. As noted above, the RMBS market has been one of the most affected by the global repricing of risk and this has had a material effect on some lenders that had relied on this market, particularly non-ADI lenders. The difficulties have been compounded by a number of institutions that have traditionally provided warehouse facilities deciding to close, or scale back, these facilities. The largest banks, however, make relatively little use of securitisation, with their outstanding securitised loans accounting for only around 6 per cent of total housing loans outstanding. The reliance on these markets varies considerably across the other Australian-owned banks, with some of these banks financing more than half of their loans through securitisation prior to the recent turmoil.

these facilities' compliance with these Standards was published in January.<sup>2</sup> Both the Reserve Bank and ASIC continue to discuss with ASX a number of issues arising from these difficulties.

## Lending and Competition

Recent developments in credit markets are having different effects across institutions and, as a result, are having a noticeable impact on competition in the Australian financial system. In the housing loan market, those lenders that have relied relatively heavily on securitisation

<sup>2</sup> See Reserve Bank of Australia (2008), 2006/07 Assessment of Clearing and Settlement Facilities in Australia, January.



Reflecting the differences in funding patterns, non-ADI lenders were among the first to raise their interest rates as funding costs rose, and have increased their advertised standard variable interest rates by an average of 40 basis points more than the increase in the cash rate since July 2007. While most other lenders have also increased their advertised rates by more than the cash rate, access to alternative sources of funding, including deposits, has meant that their funding costs have not risen by as much.

The effect of the changed competitive environment in the mortgage market is evident in recent changes in market shares, with data on housing loan approvals showing that the share of owner-occupier loan approvals by wholesale lenders (mainly mortgage originators) fell to around 6½ per cent in January 2008, compared with around 12 per cent for the previous few years (Graph 34). Conversely, the share of new loans approved by the five largest banks has risen in the past few months. In addition, with mortgage

margins under downward pressure, many lenders have re-examined their use of brokers and the commissions that they pay to these brokers.

The changed financial environment is also having a significant effect on the pricing of home loans by a number of non-conforming lenders. The vast majority of non-conforming loans are provided by specialist non-ADI lenders, with the three largest of these accounting for an estimated 70 per cent of the market. Since late last year, it is estimated that these lenders have increased their advertised interest rates by around 110 basis points more than the increase in the cash rate. In addition, a number of non-conforming lenders have adjusted their lending practices, including by reducing maximum allowable loan-to-valuation ratios, reducing the range of products they offer, and scaling back growth targets.

A number of banks have also increased the interest rates charged on credit cards and personal loans by more than the increase in the cash rate, although indications are that these markets remain quite competitive overall.

The business lending environment has also been very competitive over recent years. As discussed above, the growth of banks' lending to the household sector has moderated from its peak in 2003/04, while business credit growth has picked up significantly. One of the factors that had spurred the strong competition was the activities of some of the newer entrants into the market, including foreign-owned banks. As a group, these banks, some of which focus on large corporates, expanded their business lending at an above-average rate in recent years, with annual growth of over 30 per cent since late 2006. Reflecting this, foreign-owned banks' share

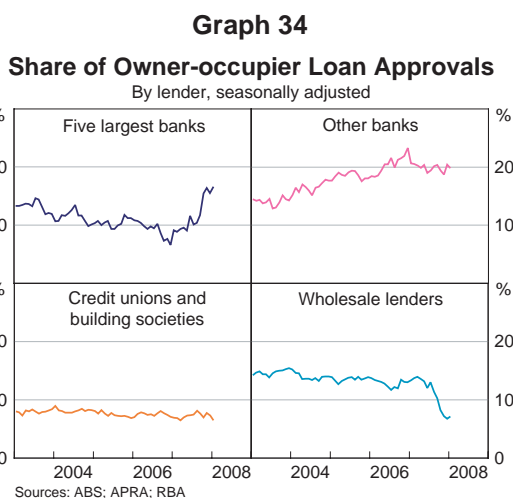

of the market for large-value loans increased to 27 per cent as at late 2007, from 23 per cent a couple of years earlier.

Notwithstanding this recent strong growth, there are signs that developments in credit markets are having an impact on competition and lending standards in the business loan market, particularly for large-value business loans. Industry liaison suggests that some lenders, particularly some foreign-owned banks, are taking a less vigorous approach to competition in this market after a number of years where lending standards had come under downward pressure. Consistent with this, some lenders appear to have scaled back their involvement in the syndicated loan market in the early part of 2008.

Competition in the market for smaller-value business loans appears to have remained firm, which may partly reflect some banks refocusing on this market as demand for housing finance moderated. One of the factors that has contributed to the strong competition in the SME market has been the increased prominence of brokers in this segment, with an estimated one fifth of SMEs now accessing finance through this channel. Banks have also focused attention on speeding up approval times for small business loans, and have increased the number of business banking staff in recent years.

## General Insurers

The Australian general insurance industry remained highly profitable over the 2007 calendar year. Insurers recorded an aggregate pre-tax return on equity of 22 per cent, which was

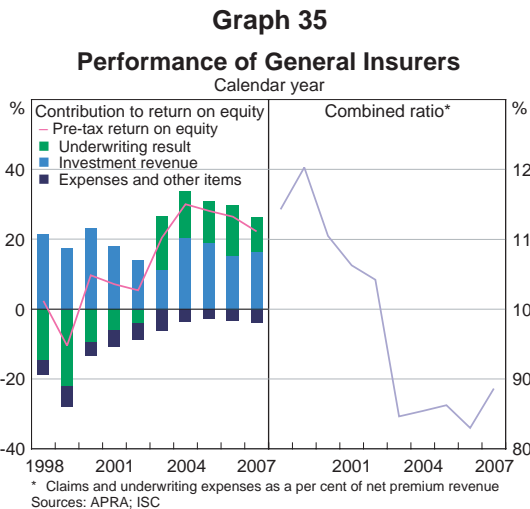

lower than in 2006, but still well above its decade-average of 14 per cent (Graph 35). As usual, the main contribution to earnings was income derived from the investment of insurance premiums. General insurers' investment mix has traditionally been relatively conservative, with fixed-interest securities accounting for around 70 per cent of total investment assets, and equities accounting for around 10 per cent in recent years. Australia's largest general insurers have not reported any direct exposures to US sub-prime risk

through their investment portfolios. Consistent with this, aggregate earnings remained quite strong in the December quarter.

Over the past year, general insurers faced a slightly more challenging claims environment than they have in recent years. Aggregate claims (net of reinsurance and other recoveries) increased by around 13 per cent, largely reflecting a series of weather-related events, including severe storms and floods in Australia's eastern states in mid to late 2007. Insurers are estimated

to have recorded around \$2 billion of Australian ‘catastrophe’ losses over the year, compared with \$0.6 billion in 2006.

Industry net premium revenue – gross premium revenue less reinsurance expenses – increased by 4 per cent, with a number of insurers citing competition in premium rates as a constraint on premium growth. This competition was most prominent in commercial business lines, where rates fell by an average of 8 per cent in 2007. In personal lines, premium rates were broadly stable on average, although there was a wide dispersion across individual business lines.

Reflecting the relatively large increase in net claims and small increase in net premium revenue, the underwriting result was weaker than in recent years. The combined ratio – claims and underwriting expenses relative to net premium revenue – increased slightly, to 89 per cent, indicating a modest deterioration in underwriting conditions.

In aggregate, Australian general insurers have a strong capital position and appear well placed to absorb any further rise in claims. As at December 2007, the industry held aggregate capital of around twice the regulatory minimum.

Notwithstanding this generally favourable picture, a form of insurance business that has attracted attention due to developments overseas is lenders’ mortgage insurance. Mortgage insurance provides protection for lenders against borrower default, and is also a form of credit enhancement in the RMBS market. In Australia, the largest non-captive lenders’ mortgage insurers (LMIs) are subsidiaries of US companies, and the US industry has recorded sharp falls in profitability since the onset of the recent turmoil. While the Australian LMIs have maintained their high credit ratings, the rating agencies have placed them on negative watch or outlook. The Australian LMI sector, however, appears to be in a sound position, holding capital equivalent to 1.2 times the regulatory minimum requirement, and it recorded solid profits in 2007. Moreover, the domestic household sector remains in good financial shape and, as a result, the value of claims in the Australian mortgage market remains low compared to the value of gross premium revenue. In addition, APRA has devoted considerable attention to strengthening the prudential framework for the LMI industry over recent years. In particular, APRA increased LMIs’ minimum capital requirements, and made them more risk sensitive, in late 2005.

Nonetheless, any downgrades would affect Australian lenders to the extent that their on-balance sheet loans are covered by mortgage insurance or the cost of issuing RMBS rose further. In Australia, almost all outstanding prime RMBS are covered by mortgage insurance, although any downgrade of LMIs would most likely only affect the relatively smaller, lower-rated tranches of RMBS. Moreover, only a small proportion of banks’ on-balance sheet loans have mortgage insurance from those LMIs that have been placed on negative credit watch.

More generally, rating agencies continue to hold a favourable view

**Table 6: Financial Strength Ratings of Selected Large Insurers**  
As at 25 March 2008

Allianz Australia Insurance	AA-
Insurance Australia Group	AA
QBE Insurance Australia	A+
Suncorp-Metway Insurance	A+
Source: Standard & Poor's	

**Graph 36**

**General Insurers' Share Prices**

1 January 2007 = 100



of the Australian general insurance industry, with each of the four largest general insurers being rated A+ or higher by Standard & Poor's (Table 6). These ratings are unchanged since the previous *Review*, though IAG was placed on negative watch in February. Share prices of the major Australian general insurers have, however, underperformed the broader market over the past year or so, reflecting a series of storm-related profit warnings and recent profit results generally coming in below market expectations (Graph 36).

**Graph 37**

**Global Insured Catastrophe Losses**

2007 prices

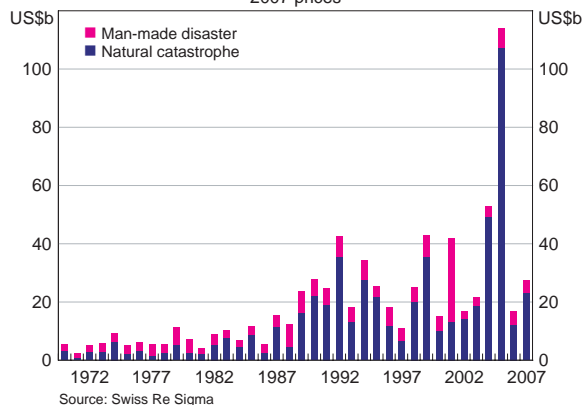

Global reinsurers – which absorb much of the risk from domestic insurers – appear to have entered the recent credit market volatility in a solid financial position, with aggregate capital estimated to be around five times the regulatory minimum. Profitability of the major reinsurers has been very strong in recent years, partly reflecting higher property reinsurance rates, and global catastrophe losses having been far lower in the past two years than in the previous two (Graph 37). Reinsurers' investment portfolios

have also generated favourable returns, and they appear to have limited exposure to assets which have come under the most stress in recent times – it is estimated that less than one per cent of total industry assets are investments directly bearing US sub-prime risk. In addition, global reinsurers also have relatively little exposure to the global financial guaranty industry; less than five per cent of net premium revenue is generated from these lines of business.

Rating agencies also maintain a positive industry rating profile for the reinsurance industry and a stable outlook. The majority of reinsurers are rated A or higher by Standard & Poor's, and the largest are rated AA or higher. However, like other segments of the financial system, credit default swap premia for the largest global reinsurers have risen sharply since mid 2007.

## Managed Funds

The funds management industry's consolidated assets under management increased by 14 per cent over the year to December 2007, to stand at nearly \$1.4 trillion, with growth much weaker over the second half of the year than in the first half of the year (Table 7).

**Table 7: Institutions' Funds under Management**

Consolidated, December 2007

	Level \$b	Share of total Per cent	Six-month-ended annualised percentage change	
			June 2007	December 2007
			Per cent	Per cent
Superannuation funds	802.4	58.9	31.0	6.3
Life insurers <sup>(a)</sup>	220.8	16.2	17.0	-1.7
Public unit trusts	278.5	20.4	19.5	0.4
Other managed funds <sup>(b)</sup>	61.4	4.5	37.2	-3.2
<b>Total</b>	<b>1363.1</b>	<b>100.0</b>	<b>26.3</b>	<b>3.3</b>
<i>Of which:</i>				
All superannuation assets <sup>(c)</sup>	1001.2	73.5	28.2	4.8

(a) Includes superannuation funds held in the statutory funds of life insurers

(b) Cash management trusts, common funds and friendly societies

(c) Superannuation funds plus an estimate of the superannuation assets held in the statutory funds of life insurers

Sources: ABS; RBA

## Superannuation Funds

Superannuation funds' assets under management increased by \$122 billion, or 18 per cent, over the year to December 2007. This partly reflected strong inflows of new funds in the first half of the year, mainly associated with the changes to superannuation taxation arrangements that came into effect on 1 July 2007. In the June quarter alone, net contributions were \$33 billion, compared to an average of \$10 billion per quarter over the previous three years (Graph 38).

Notwithstanding the strong inflows in the first half of 2007, investment returns have comprised the bulk of superannuation funds' income in recent years. While aggregate data on returns for the December quarter are not yet available, many funds have reported significantly lower investment returns in the recent period, due

**Graph 38**

### Superannuation Funds' Financial Performance\*

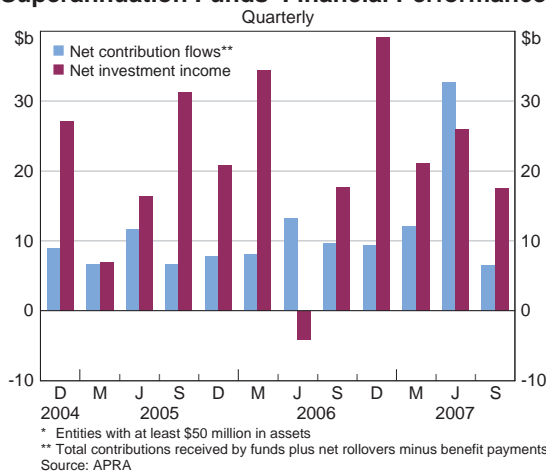

to the downturn in global and Australian equity markets. Around half of superannuation funds' assets were held in equities and units in trusts as at December 2007, and growth in these assets moderated significantly over the second half of 2007 (Table 8). Australian superannuation funds appear to have minimal direct exposures to the problems in US sub-prime related debt markets, although several funds have modest holdings of CDOs backed by US sub-prime debt. This low exposure is consistent with aggregate data showing that only 4 per cent of superannuation funds' financial assets are invested in offshore bonds (including CDOs).

**Table 8: Superannuation Funds' Assets**

Unconsolidated, December 2007<sup>(a)</sup>

	Level \$b	Share of total Per cent	Six-month-ended annualised percentage change	
			June 2007	December 2007
			Per cent	Per cent
Cash and deposits	110.9	11.5	69.0	-1.5
Loans and placements	7.9	0.8	18.9	4.2
Short-term securities	37.2	3.8	21.4	3.5
Long-term securities	52.7	5.5	-0.6	6.8
Equities	339.0	35.1	32.5	6.5
Units in trusts	143.2	14.8	23.4	12.5
Other assets in Australia	60.2	6.2	51.3	-7.2
Assets overseas	215.8	22.3	23.8	18.8
<b>Total</b>	<b>967.0</b>	<b>100.0</b>	<b>31.1</b>	<b>7.9</b>

(a) Not adjusted for cross-investments with other managed fund sectors  
Source: ABS

## Life Insurers

Life insurers' assets grew by 7 per cent over the year to December 2007, and account for around 16 per cent of the funds management industry. With superannuation assets accounting for around

**Graph 39**

### Life Insurers' Financial Performance

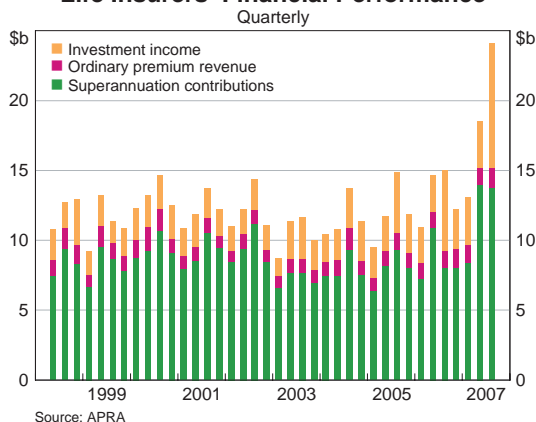

90 per cent of life insurers' total assets, the inflow of new business was particularly strong in the June quarter of 2007 (Graph 39). In contrast to the broader superannuation industry, inflows remained strong in the September quarter. Although a declining share of life insurers' income has come from traditional life business, the growth in income from this form of business has been stronger in the past two years than it has been for some time. This partly

reflects increased volumes of group life business written via industry and other public offer superannuation funds.

As has been the case for superannuation funds, investment income has accounted for a significant share of life insurers' asset growth. Over recent years, this has reflected the strong growth of the equity market, with around 50 per cent of life insurers' statutory fund assets held in the form of Australian equities and units in trusts, up from 30 per cent in the mid 1990s. With the Australian equity market having fallen by around 25 per cent since its peak last year, the growth in investment returns is likely to have moderated in more recent quarters.

Looking ahead, with only 10 per cent of life office assets now related to writing risk insurance, the prospects for the life insurance sector are likely to remain closely tied to developments in superannuation. Notwithstanding this, some commentators have argued that households are 'under insured', which may give scope for risk business to increase in the future. Some life insurers have also streamlined their application processes, typically through the use of online applications.

### Public Unit Trusts and other Managed Funds

Outside of superannuation funds and life offices, the majority of funds under management are invested in public unit trusts, which grew by 9 per cent over the year to December 2007, though growth was entirely confined to the first half (Table 9). The value of listed property and unlisted equity trusts (which together account for nearly 80 per cent of all unit trust assets) fell in the second half of 2007. As noted above, the performance of these, and other unit trusts, has been affected by the recent falls in share prices in Australia and overseas, as well as by the difficulties of several large property companies in recent months. However, while several Australian hedge funds collapsed in the early stages of the turmoil, there have been no announcements more recently of severe stresses in the sector.

**Table 9: Public Unit Trusts' Assets**

Unconsolidated, December 2007<sup>(a)</sup>

	Level \$b	Share of total Per cent	Six-month-ended annualised percentage change	
			June 2007 Per cent	December 2007 Per cent
Listed property trusts	120.9	38.5	30.9	-2.5
Listed equity trusts	36.9	11.8	27.4	15.8
Unlisted equity trusts	122.4	39.0	14.5	-3.5
Other trusts	33.8	10.8	-6.1	5.3
<b>Total</b>	<b>313.9</b>	<b>100.0</b>	<b>19.2</b>	<b>-0.2</b>

(a) Not adjusted for cross-investments with other managed fund sectors

Source: ABS





# Household and Business Balance Sheets

As noted in the most recent *Statement on Monetary Policy*, the Australian economy has grown strongly over recent years and this has underpinned favourable conditions for the household and business sectors. There have been substantial gains in the household sector's net wealth and business profitability has been strong. Reflecting these developments, the share of households and businesses not able to meet their debt obligations remains at low levels. Despite this overall positive picture, there are nonetheless pockets of stress in both the household and business sectors, with tighter credit conditions placing greater pressure on some balance sheets than has been the case in the recent past. In the business sector, those firms whose balance sheets are highly geared and who have been reliant on short-term funding have been particularly affected.

## Household Sector

Over recent years, the household sector has benefited from favourable labour market conditions and strong income growth. The unemployment rate is currently at its lowest level in over 30 years, and in 2007, real disposable income *per household* increased by 6 per cent, around the fastest rate in nearly two decades (Graph 40). This strong growth in disposable incomes mainly reflected solid gains in both employee and investment incomes, as well as lower taxes.

The household sector has also benefited, for more than a decade, from strong growth in its net asset position. Household net worth in the September quarter 2007 (the latest period for which figures are available) was equivalent to almost 7 times annual household disposable income, up from around 5 times in the mid 1990s (Graph 41). With the value of household assets increasing broadly in line with household debt over the past couple of years, the overall household gearing ratio has been broadly steady at around 17 per cent over this period, after having increased substantially over the previous decade.

Growth in the value of households' non-financial assets – largely housing – has picked up over the past 18 months, as housing markets in a number of areas of the country have strengthened. Nationwide, average established house prices rose by 12 per cent over the year to the December quarter 2007, well above the average annual growth rate of around 4 per cent seen over the

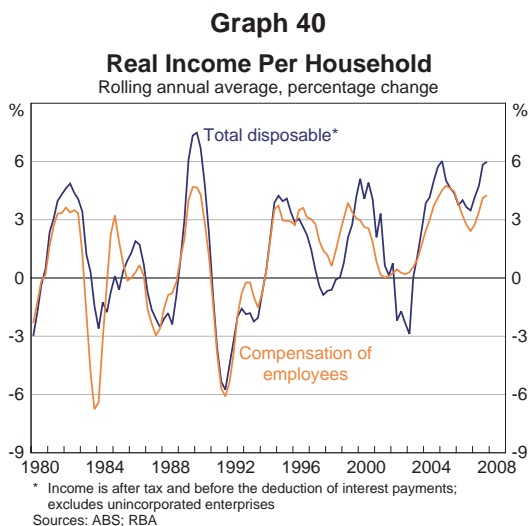

**Graph 41**  
**Household Balance Sheets**

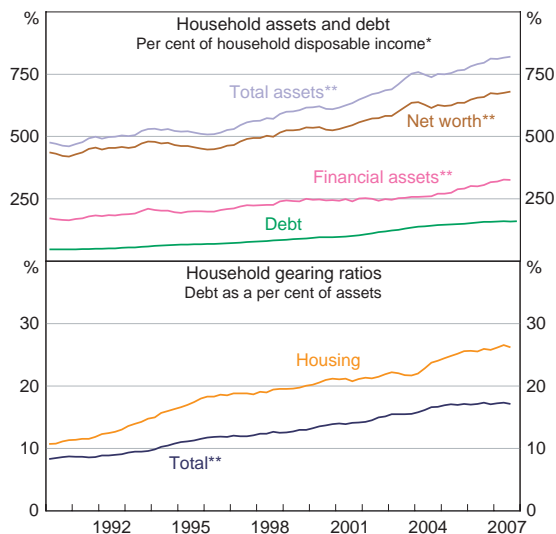

\* Income is after tax and before the deduction of interest payments; includes income of unincorporated enterprises in all ratios except for household debt to income

\*\* Includes financial assets of unincorporated enterprises  
Sources: ABS; RBA

**Table 10: Household Assets**  
Per cent

	Share of total September 2007	Year-ended growth September 2007
Non-financial assets	60.2	10.2
Dwellings	56.1	10.5
Consumer durables	4.1	5.5
Financial assets <sup>(a)</sup>	39.8	17.1
Superannuation and life offices <sup>(b)</sup>	22.9	21.1
Equities and units in trusts	7.4	17.7
Currency and deposits	7.7	10.0
Other	1.8	1.4
<b>Total</b>	<b>100.0</b>	<b>12.8</b>

(a) Includes assets of unincorporated enterprises

(b) Includes unfunded superannuation

Sources: ABS; RBA

previous three years. Growth in prices over 2007 was stronger in most capital cities; the exception was Perth, where prices were broadly flat after particularly strong rises in the previous three years.

The value of households' holdings of financial assets also increased strongly over the year to September 2007, rising by 17 per cent, well above the average annual increase of 11 per cent recorded over the past decade (Table 10). This increase largely reflected valuation gains flowing from strong asset markets, though net inflows into superannuation were also sizeable, boosted by a surge in contributions in the June quarter ahead of the introduction of lower limits for concessional taxation of contributions on 1 July 2007. More recently, the value of households' financial assets has been negatively affected by weakness in the share market, with the ASX 200 index down by 24 per cent since the end of October 2007.

Reflecting these generally favourable conditions over recent years, housing loan arrears remain at levels that are low by both historical and international standards. Indeed, over the second half of 2007, arrears rates fell slightly, after having increased from record lows over the previous three years. As at end December 2007, the ratio of the value of non-performing housing loans to total housing loans on

banks' domestic books stood at 0.32 per cent, unchanged from a year earlier (Graph 42). Of these non-performing loans, most were well covered by collateral.

The 90-day arrears rate for housing loans that have been securitised was also broadly unchanged over 2007, and stood at 0.40 per cent in December. The arrears rate on securitised

loans has, on average, been a little higher than that for loans on banks' balance sheets, partly reflecting the higher share of low-doc loans in the securitisation pool. For low-doc loans, the 90-day arrears rate was 0.70 per cent in November 2007, more than double that for prime full-doc loans, but broadly around the level of a year ago (Graph 43). In contrast, the arrears rate on non-conforming loans – which are made to borrowers with poor credit histories – has risen significantly over the past few years to stand at 7.25 per cent. These loans, however, account for less than one per cent of outstanding housing loans in Australia.

The available data suggest that, in recent years, the average outstanding balance on housing loans that are in arrears has been higher than the average outstanding balance on all housing loans. This is partly due to the fact that loans that are larger at origination have tended to have higher arrears rates than smaller loans. In addition, as discussed below, the arrears rate has been higher in New South Wales than in other parts of Australia, with loans in this state tending

to be for larger amounts than the national average. As a result, the *number* of housing loans 90-days past due as a share of the total number of housing loans is smaller than the comparable figure for the *value* of housing loans (Graph 42). It is estimated that, at present, around 15 000 borrowers are more than 90 days behind on their mortgage repayments, while an additional 25 000 are between 30 days and 90 days in arrears.

The general pattern of housing loan arrears having moved sideways over the past year is also evident in personal and credit card loan arrears (Graph 44). As at December 2007, the non-performing rate for personal loans was 0.8 per cent, and for credit cards the equivalent figure was 1.0 per cent.

Although the aggregate data continue to suggest that household finances are in sound shape, experience varies widely across households and across regions, with housing loan arrears

**Graph 42**  
**Non-performing Housing Loans**  
Per cent of outstandings

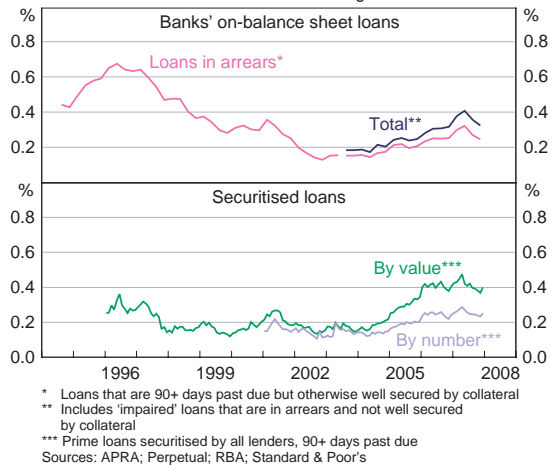

**Graph 43**

**Housing Loan Arrears\***

90+ days past due, per cent of outstandings

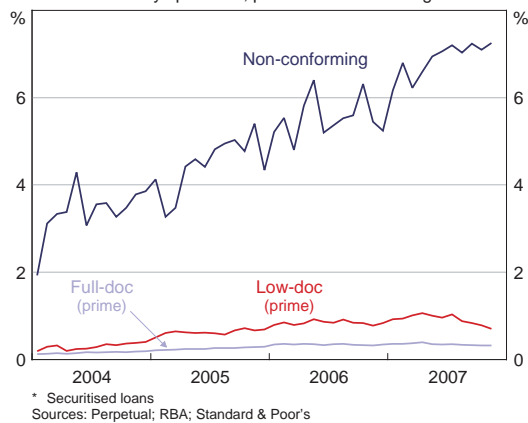

**Graph 44**  
**Banks' Non-performing Personal Loans**  
 Per cent of outstandings by loan type\*

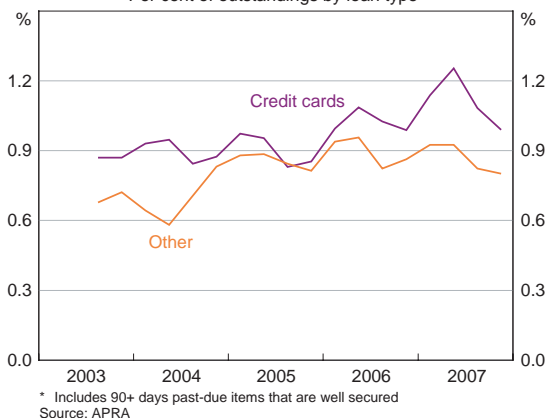

**Graph 45**  
**Housing Loan Arrears by State\***  
 90+ days past due, per cent of outstandings

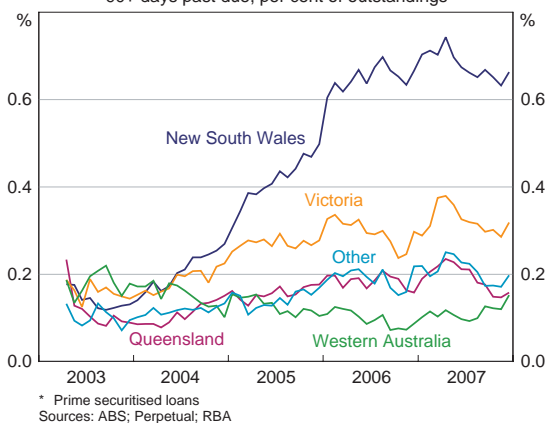

noticeably higher in NSW than in the other states (Graph 45). Within NSW, the increase in arrears rates has been highest in western Sydney, where economic conditions have been relatively weak, house prices have been under downward pressure, and the share of households with high owner-occupier debt-servicing ratios is considerably greater than in other parts of the country. Arrears rates in this part of Sydney increased markedly over the period from 2003 to mid 2006, but like much of the rest of the country have since moved broadly sideways (Graph 46). In contrast, there have been falls in arrears rates in a number of other parts of Sydney over the past year or so, and in some areas they are only slightly above the very low levels of 2003.

The pick-up in the arrears rate in NSW since 2003 has resulted in a rise in the number of court applications for property repossession although, consistent with a levelling out in the arrears data, the rate of applications for repossession did not increase further over 2007, with recent

monthly data suggesting a small decline (Graph 47). A broadly similar pattern is evident in Victoria, the only other state for which data are currently available.

The ratio of repossession applications in NSW to the dwelling stock is presently more than double that in the mid 1990s, with this increase larger than can be accounted for by the change in the arrears rate. This apparent change in the relationship between repossession applications and arrears is partly explained by the emergence of some non-ADI lenders that are more likely than ADIs to seek repossession. It is also likely to reflect differences in housing price dynamics in these periods: the weakness over the past few years in some housing markets has increased the likelihood that a borrower experiencing difficulties is unable to clear their debt by selling the property, which in turn has increased the likelihood of repossession. Consistent with this, APRA data show that almost two thirds of lenders' mortgage insurance claims in the year to June 2007 were from NSW (including ACT), despite this state representing only one third of these insurers' premium revenue.

The general increase in arrears rates since their trough around 2003 partly reflects the greater availability of credit over the past decade. The easing of credit standards over this period meant that many borrowers who in the past may not have been eligible for a housing loan have been able to obtain finance, and many others have been able to borrow larger amounts. One consequence of this is that for any set of economic and financial conditions, arrears rates are likely to be higher than in the past.

Looking forward, an increase in arrears is likely due to both the further working out of this structural adjustment, and the recent tightening of financial conditions for the household sector. Since July 2007, interest rates paid on new prime full-doc loans and new prime low-doc loans have increased by about 125 basis points and 140 basis points, respectively, while rates for more risky non-conforming loans have risen by around 210 basis points.

These tighter financial conditions have contributed to a slowing in the overall pace of household credit growth. Borrowing for housing –

which accounts for around 86 per cent of household debt – increased by 11½ per cent over the year to January 2008, down from 13½ per cent growth in the previous year, with recent data on housing loan approvals suggesting that a further slowing in credit growth is likely (Graph 48).

Personal credit has grown at a broadly similar rate as housing credit recently, although the various components of personal credit have shown distinctly different patterns. Year-ended growth in credit card debt was 9 per cent in January 2008, close to the slowest rate of growth in nearly 15 years. In contrast, growth in margin debt (which accounts for around one-fifth of personal credit, but only 3 per cent of total household debt) was particularly strong up until June 2007, when six-month-ended annualised growth peaked at around 65 per cent (Graph 49). Subsequently, substantial falls in share prices in the September quarter, and more recently, have contributed to a marked fall in the growth of outstanding margin debt. Recent developments

**Graph 46**

**Housing Loan Arrears in NSW\***  
90+ days past due, per cent of outstandings

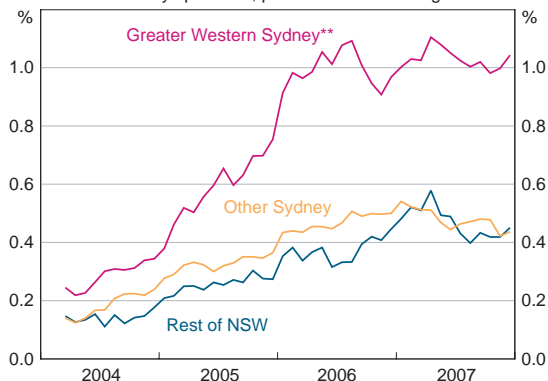

\* Prime securitised loans  
\*\* Blacktown, Canterbury-Bankstown, Fairfield-Liverpool, and Central Western, Inner Western, Outer South Western and Outer Western Sydney regions  
Sources: ABS; Perpetual; RBA

**Graph 47**

**Applications for Property Possession\***  
Per cent of dwelling stock

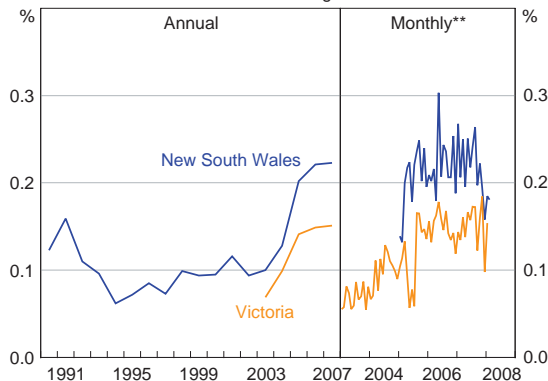

\* Includes applications for possession of some commercial, as well as residential, properties  
\*\* Annualised  
Sources: ABS; Supreme Courts of NSW and Victoria

**Graph 48**  
**Household Credit**  
 Year-ended percentage change

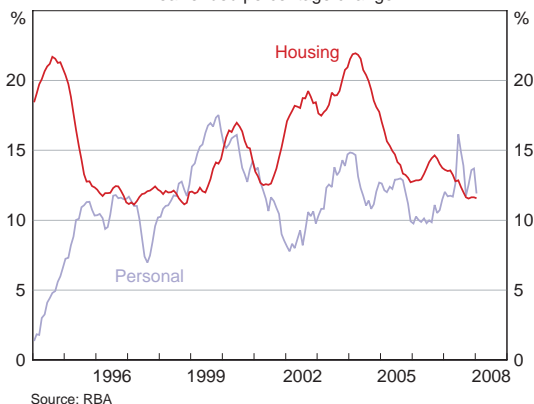

**Graph 49**  
**Margin Lending**

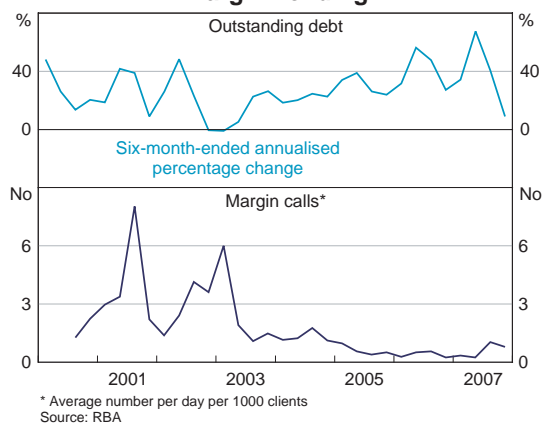

**Graph 50**  
**Fixed-rate Housing Loans**  
 Per cent of the value of owner-occupier approvals

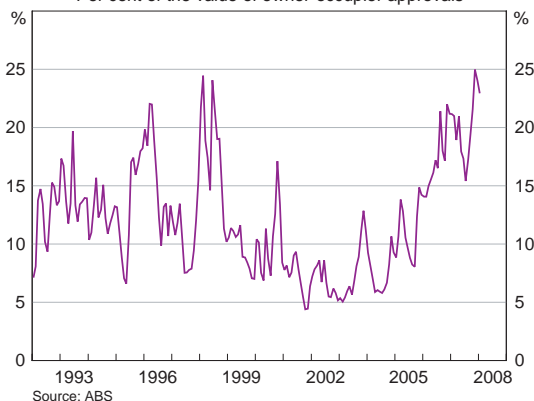

have also seen a significant rise in the frequency of margin calls: the number of calls roughly doubled in the second half of 2007, with partial data suggesting there has been a further sharp increase since the beginning of 2008. While margin calls have caused financial difficulties for some borrowers, relatively few households are affected, with data from the Household, Income and Labour Dynamics in Australia (HILDA) Survey indicating that only 3 per cent of households held margin debt in 2006. Margin loans are also relatively conservatively geared on average, at around 40 per cent.

The recent tightening in household financial conditions is evident in surveys of consumer sentiment which have shown a significant decline in the proportion of households that are optimistic about their current and future financial circumstances; higher interest rates, rising fuel prices and the weaker share market have all likely weighed on consumer confidence. Rising interest rates have also seen a greater number of households opt for fixed-rate loans – in recent months around one quarter of the value of new owner-occupier housing loans were taken out at fixed rates, an historically high share (Graph 50).

With growth in outstanding debt exceeding that in income, and interest rates rising, the ratio of aggregate household interest payments to household disposable income has continued to rise (Graph 51). The ratio is likely to have reached

around 13 per cent in the March quarter 2008.

These higher interest payments will clearly have a negative effect on some households, and trends in household finances will warrant especially close monitoring in the period ahead. The rise in the aggregate interest-payment ratio does, however, overstate the rise in the *average* interest-payment ratio for individual indebted households; this latter ratio is currently around the same level as in the late 1980s (Graph 52). The rise in the aggregate ratio partly reflects a rise in the proportion of households with owner-occupied debt, most notably among older age groups, who appear more willing to carry debt later in life than was the case with previous generations. It also reflects a rise in the share of households with investor loans; according to HILDA Survey data, the proportion of households with investor housing debt rose from 8 per cent to 10 per cent over the four years to 2006.

Assessments of how the household sector's capacity to service debts is changing through time also need to take into account the ability and willingness of households to spend a

greater proportion of their income on housing as income and wealth increases. As incomes rise, a household with a given debt-servicing ratio will have a larger *absolute* amount of income left over after debt repayments to meet other living expenses. This means that an increase in the debt-servicing ratio does not necessarily imply greater financial strain, thereby lessening the usefulness of historical benchmarks defining housing stress. Estimates from the HILDA Survey indicate that, after subtracting debt repayments (interest and principal repayments, including any excess repayments), real median disposable income of households with owner-occupier debt increased by an average rate of around 1¼ per cent per annum over the four years to 2006, despite strong growth in housing credit and rising interest rates.

**Graph 51**  
**Household Interest Payments\***  
Per cent of household disposable income

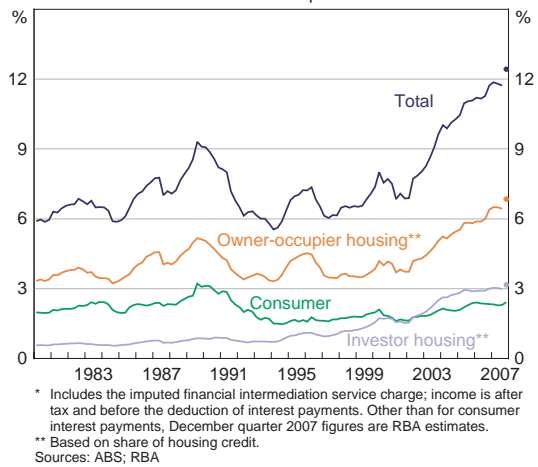

**Graph 52**  
**Owner-occupier Housing Interest Payments\***  
Per cent of household disposable income

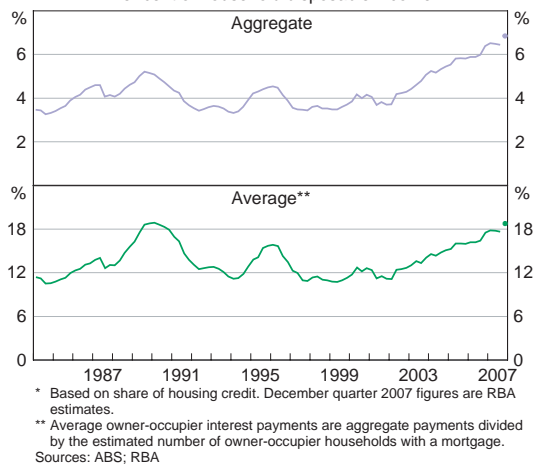

Assessments of the state of the household sector's finances also need to take into account the large differences in the financial positions of different households. The most comprehensive data currently available are from the HILDA Survey, for 2006. This survey includes a number of questions seeking to ascertain households' own perceptions of their finances. While the results suggest that at any point in time a small proportion of households is always under financial strain, this fraction has declined steadily over recent years (see Box C).

**Graph 53**

**Debt-servicing Ratios**

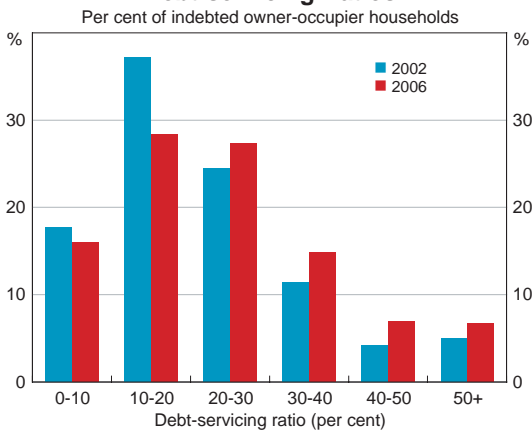

**Graph 54**

**Gearing Ratios\***

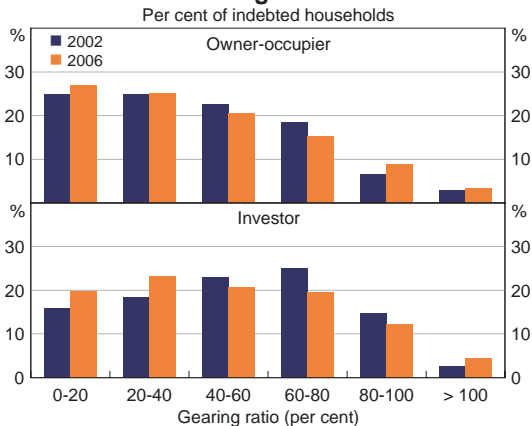

The HILDA Survey also provides details of how gearing and debt-servicing ratios vary across households. In 2006, around 14 per cent of households with an owner-occupier mortgage reported a debt-servicing ratio of greater than 40 per cent, up from 9 per cent in 2002 (Graph 53). It also showed that almost half of households with mortgages over their own home had debt-servicing ratios of less than 20 per cent. In terms of gearing, in 2006 only 12 per cent of owner-occupier households reported that their outstanding mortgage debt was greater than 80 per cent of the value of their home, with 52 per cent reporting gearing ratios below 40 per cent (Graph 54). Among investors, gearing ratios are typically higher, although gearing has generally declined since 2002.

As noted earlier, recent falls in equity and other financial prices have negatively affected the value of households' financial assets. Over the past decade or so, there has been a substantial increase in the household sector's holdings of market-linked financial assets, particularly equities

and superannuation, increasing the household sector's exposure to financial market volatility. At the end of September 2007, holdings of equities and superannuation were equivalent to around 250 per cent of annual household disposable income, up from around 100 per cent in 1990 (Graph 55). In contrast, currency and deposits – the value of which typically does not vary with market valuations – have risen only slightly relative to income since 1990, and were equivalent to around 65 per cent of disposable income as at September 2007. Since expected capital returns on



market-linked assets are higher than those for currency and deposits, these changes in asset composition could be expected to contribute to increased household wealth over time, as well as allowing for greater diversification of households' investment portfolios. Nonetheless, the increased holdings of market-linked financial assets raises the possibility that periods of sharp adjustment in financial markets – such as that seen recently – have a larger effect on household confidence and spending than has been the case in the past. For further details on the household sector's exposure to market risk see Box D.

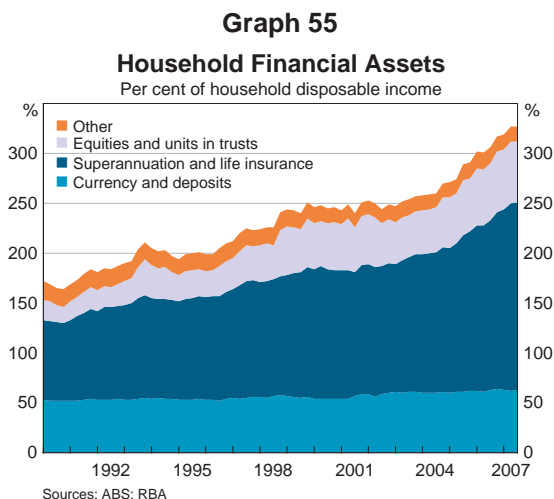

In summary, the recent tightening of financial conditions and weaker financial asset markets are putting more pressure on many households' finances than has been the case in recent years, a period in which the household sector has benefited from strong growth in incomes and wealth. Looking ahead, arrears rates on loans could be expected to increase somewhat from current levels, which are low by historical and international standards. Household finances overall, however, remain in sound shape, although there are continuing pockets of stress. In the months ahead, the Reserve Bank will continue to closely monitor developments in household balance sheets, both at the aggregate and disaggregated level.

## Business Sector

Like the household sector, the business sector in Australia has benefited from favourable economic and financial conditions over recent years. As a result, at the aggregate level, business balance sheets are in healthy shape, profitability is high, and both debt-servicing requirements and arrears rates are at relatively low levels. Notwithstanding this positive picture, the recent sharp increase in financial market risk aversion and higher funding costs have created difficulties for some firms, particularly those with highly leveraged balance sheets, and those that have relied heavily on short-term funding.

The strong overall position of business balance sheets in recent years has been underpinned by strong profit growth, with profits of the non-financial business sector trending up as a share of GDP, to currently stand at around a multi-decade high (Graph 56). Over the year to the December quarter 2007, profits grew by 7 per cent, which is around the average rate of growth for the past decade. Within the total, there has recently been a fall in profits of the mining sector although, as a share of GDP, the sector's profits remain at a high level. In contrast, profits of the non-mining, non-farm sector of the economy have increased strongly recently, rising by around 11 per cent over the year to the December quarter.

**Graph 56**  
**Business Profits\***  
Per cent of GDP

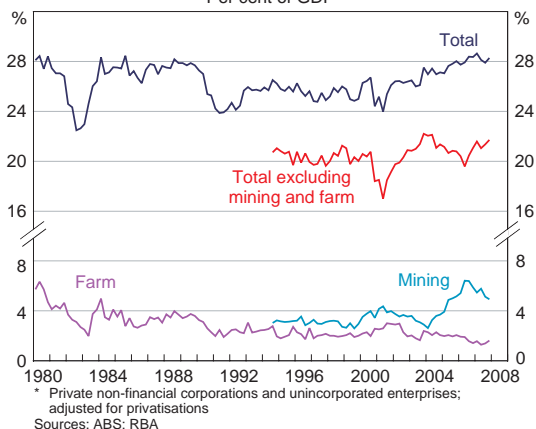

**Graph 57**  
**Business Funding and Investment**  
Rolling annual average, per cent of GDP

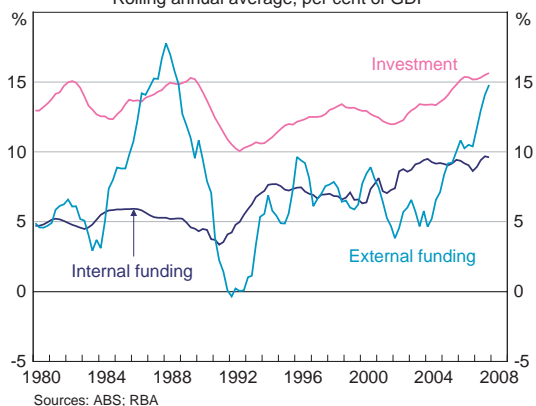

**Graph 58**  
**Listed Non-financial Companies' Gearing Ratios\***

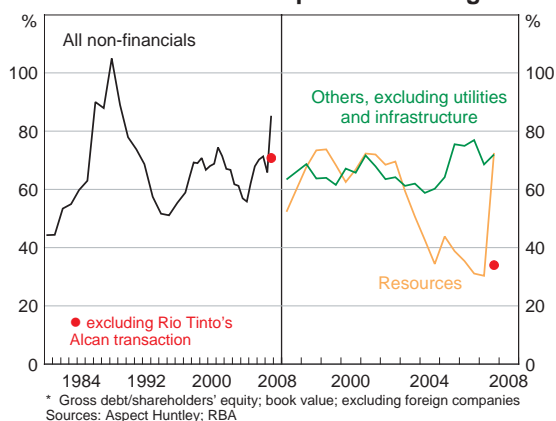

For a number of years, the strength in profits allowed the business sector to finance high levels of investment with only limited recourse to external funding. But more recently there has been a substantial increase in businesses' utilisation of external funds, particularly debt. Over the year to the December quarter 2007, external funding accounted for around 60 per cent of new business finance and was equivalent to 15 per cent of GDP, up from 6 per cent in 2003 (Graph 57). While some of this increase in total funding has been used to finance a further pick-up in the ratio of investment to GDP, there has also been a substantial increase in businesses' holdings of financial assets.

These aggregate data, however, disguise quite different trends across sectors. In particular, the very high levels of profits (and hence retained earnings) in the mining sector had led to a marked reduction in this sector's leverage over recent years. In late 2007, however, Rio Tinto's debt financing of its takeover of Alcan saw this trend reverse. Abstracting from this transaction, there was still an up-tick in gearing, but it remains at relatively low levels (Graph 58).

For listed non-resource companies, the strength of business credit has been associated with an increase in gearing over recent years. While there has been a general trend towards higher gearing levels, a substantial part of the increase in aggregate gearing for non-resource companies has been due to the

growth in utilities and infrastructure companies. Whereas a few years ago these companies accounted for only around 18 per cent of total debt being carried by listed non-financial companies, as at December 2007 this share had increased to around 25 per cent. Moreover, these companies are much more highly geared than other non-resource companies, though given the nature of their businesses they would appear to be relatively well positioned to service these larger debt burdens.

Over the year to January, business credit increased by 24 per cent, its fastest rate since the late 1980s (Graph 59). Part of this recent rapid growth is accounted for by large businesses turning to banks for funding, with conditions in capital markets making it difficult to raise non-intermediated debt. Reflecting

this, data from APRA indicate that the outstanding value of banks' business loans that are greater than \$2 million rose by 41 per cent over the year to December 2007, compared with much slower growth for loans of smaller sizes (Table 11). Conversely, over the second half of 2007, there was minimal issuance of corporate bonds which, together with maturities of existing debt, resulted in a fall in the stock of non-intermediated debt. The decline in the second half of the year was equivalent to 2 per cent of GDP, the biggest decline in over 20 years. Nonetheless, taking account of both intermediated and non-intermediated debt funding, it is estimated that business debt increased by around 19 per cent over the year to January 2008.

Banks' business loan interest rates have risen considerably since mid 2007, with these increases having been broadly in line with banks' increased funding costs in wholesale markets. Rising interest rates, together with strong growth in business borrowing, has resulted in a modest rise in

**Graph 59**

**Business Funding**

Year-ended percentage change

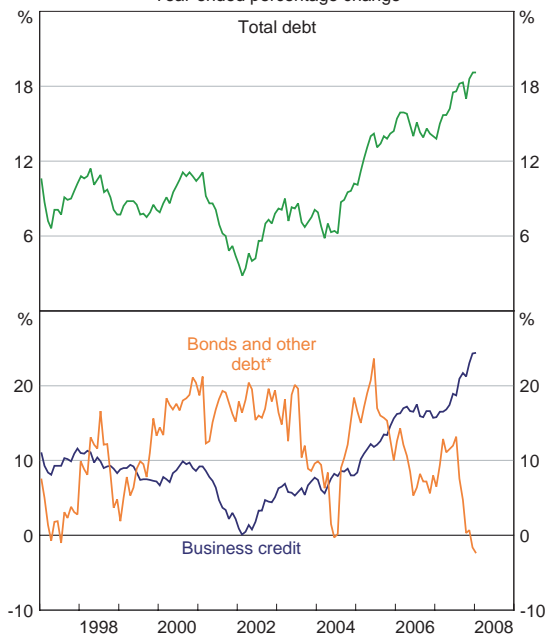

\* Exclusive of promissory notes held by all financial intermediaries  
Sources: ABS; ASX; Austraclear; RBA

**Table 11: Banks' Business Lending**

December 2007, by loan size

Loan size	Level \$b	Share of total Per cent	Year-ended growth Per cent
Less than \$500 000	94.1	15.0	4.7
\$500 000 to \$2 million	95.1	15.1	14.0
Greater than \$2 million	438.5	69.9	41.3

Source: APRA

**Graph 60**  
**Non-performing Business Assets**  
 Banks' domestic books, by type of business

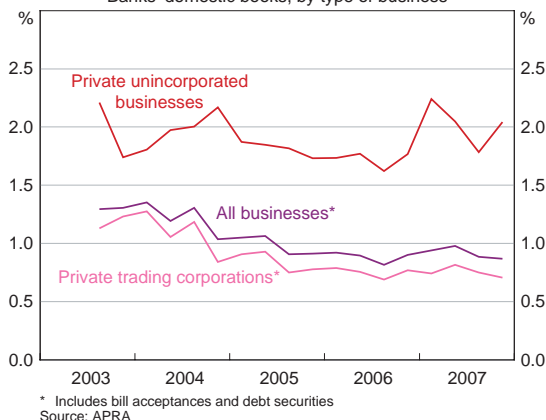

**Graph 61**  
**Corporate Credit Risk\***

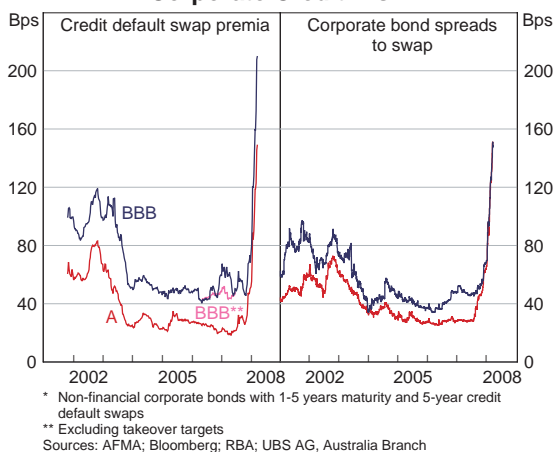

the ratio of non-financial businesses' interest payments to profits over the past two years. While this ratio is currently around its highest level in a decade and a half, it remains well below the levels seen in the 1980s.

Reflecting the generally positive conditions of recent years, arrears rates on banks' business loans have trended down, and are at low levels. As at end December 2007, around 0.9 per cent of banks' business credit was non-performing, down from 1.3 per cent four years earlier. This decline is largely accounted for by lower rates of arrears on loans to corporations, with arrears rates for loans to unincorporated enterprises broadly unchanged over this period (Graph 60). Further, the bankruptcy rates for corporations and unincorporated enterprises remain around their long-run averages, and there has been no default on a (rated) corporate bond since 2004.

Despite evidence that the overall financial position of the business sector is strong, there has been a sharp repricing of corporate debt, consistent with developments overseas. Credit default swap premia

have widened considerably since the end of October 2007, as have corporate bond spreads, and are now significantly higher than levels seen in 2001 and 2002 (Graph 61).

The change in the financial environment over the past six months has had a significant effect on some firms' ability to obtain finance, and the terms under which others are able to obtain funding. Companies that have relied on short-term debt to finance balance-sheet expansion and/or that have developed complex structures and engaged in significant financial engineering are being forced to simplify and de-leverage their balance sheets. A number of these companies have had difficulty making the changes required by lenders and investors, and have suffered very large declines in their share prices. However, an examination of listed companies' balance sheet data suggests there are relatively few firms that have both high gearing and a high proportion of debt that is short term. An analysis of more than 300 listed companies with assets in excess of \$100 million as at December 2007 shows that, among those with a debt-to-assets ratio in

the top quintile (around 40 per cent or greater), less than 20 had short-term debt in excess of 50 per cent of total debt.

As well as sharp increases in corporate bond spreads, there have been significant falls in the share prices of listed companies in the past six months. While these declines have been partly due to overall financial market turbulence, they also reflect increased uncertainty regarding earnings prospects. Since the end of October 2007, share prices of both resource companies and other non-financial companies have fallen by a little under 20 per cent (Graph 62). However, even after these sharp declines, share prices of resource companies are still over 25 per cent higher than at the start of 2007, and price/earnings ratios for this sector are only a little below their longer-run averages (Graph 63). In contrast, share prices of other non-financial companies are around 9 per cent below where they started in 2007, and the current price/earnings ratio for these companies is well below the average since the mid 1990s.

One market that will bear close watching in the period ahead is the commercial property market. Office vacancy rates are low across the country, and prices and rents have increased sharply (Graph 64). The pressures are particularly pronounced in the Perth and Brisbane markets where there is currently very little vacant office space available. Average rents in both cities for prime office space are now more expensive than in Sydney, increasing the possibility

**Graph 62**  
**Share Price Indices**  
End December 2005 = 100

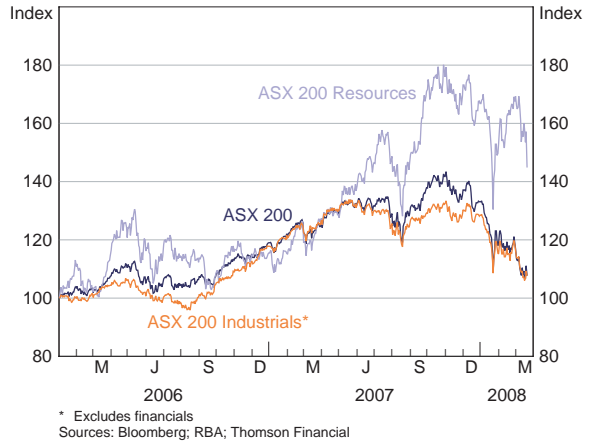

**Graph 63**  
**Australian P/E Ratios\***

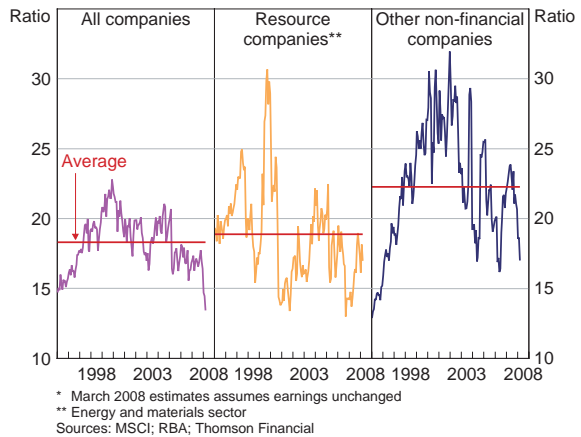

**Graph 64**  
**Office Property Indicators**

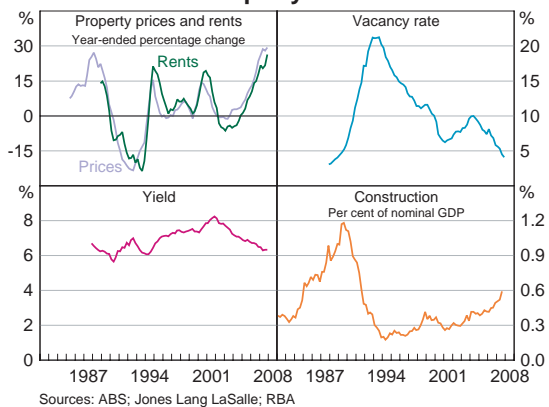

**Graph 65**  
**Office Capital Values and Rents**

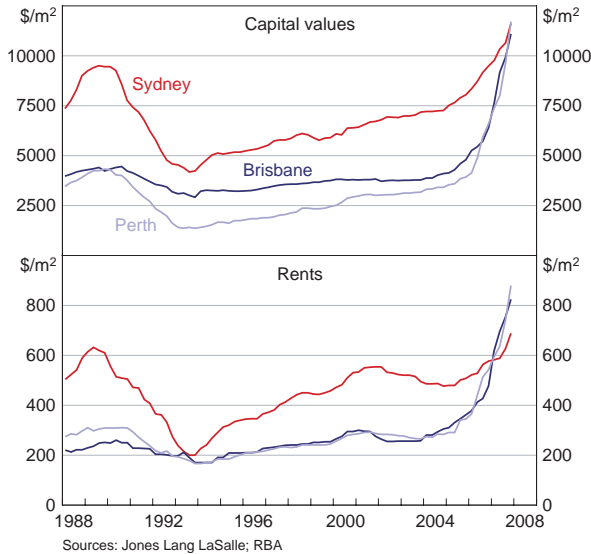

of a correction at some point in the future (Graph 65). The tightness has prompted a noticeable pick-up in actual and planned construction, with the office supply in each of these cities projected to increase by an average of 8 per cent in each of the next three years, compared with average annual stock additions of 2 per cent over the past decade. Nationally, office construction investment as a share of GDP is at its highest level for more than a decade and a half, although well below the very high levels recorded during the second half of the 1980s.

Associated with the strength of the commercial property market, bank lending for office property increased by 36 per cent over the year to September 2007 (the most recent data), a significantly faster rate of growth than for aggregate business credit. As at September 2007, banks' lending for office buildings comprised 7½ per cent of outstanding business credit, compared with 3½ per cent a decade ago. As noted in *The Australian Financial System* chapter, the share of banks' commercial property lending that is impaired picked up slightly over the year to September 2007, but remains low by historical standards. More recently, liaison has suggested that bank financing for commercial property developments is becoming more difficult to obtain than had previously been the case.

Associated with the strength of the commercial property market,

## Box C: Survey-based Indicators of Household Finances

Data on housing and credit card arrears provide a timely indication of households' ability to meet their debt obligations. As discussed in the *Household and Business Balance Sheets* chapter, arrears rates on household loans have risen a little over recent years, but remain low by both historical and international standards. Another – albeit less timely – source of information on the financial position of households is provided by the Household, Income and Labour Dynamics in Australia (HILDA) Survey, which is conducted annually.

Among other things, the HILDA Survey asks each participating household a series of seven questions on whether it has experienced various specific financial difficulties during the year due to shortages of money (including, for example, difficulties in paying bills, seeking financial help or selling personal possessions). The results from the surveys undertaken since 2001 show a steady decline in the share of households reporting such problems (Graph C1).<sup>1</sup> The decline is most pronounced for the share of households that report that they had to delay payment of a utility bill at least once during the year, although it is also evident in all other specific examples of financial difficulty.

There has also been a marked decline in the share of households that report multiple occurrences of these cash-flow-related financial difficulties. For example, in 2006 around 5½ per cent of households reported positive responses to three or more of the seven questions, down from 10 per cent in 2001 (Graph C2). Renter households were more likely than indebted owner-occupiers to experience multiple cash-flow-related difficulties: in 2006, 14 per cent of renters reported three or more positive responses, compared with 4 per cent of indebted owner-occupiers. In aggregate, indebted owner-occupier households reporting positive responses to three or more questions held only 3½ per cent of outstanding owner-occupier debt in 2006.

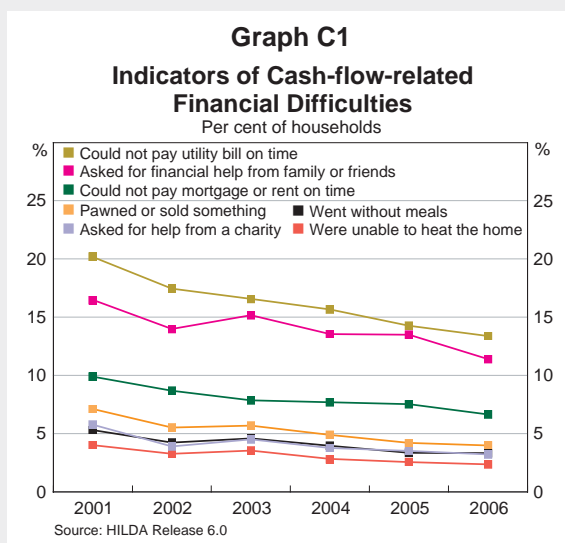

<sup>1</sup> Survey respondents are asked on a 'yes/no' basis whether they experienced a particular difficulty at any time during the year in which the survey was undertaken. Consequently, the proportions shown in Graph C1 are most likely an overstatement of the persistence of occurrences of each type of difficulty.

**Graph C2**  
**Households Experiencing Multiple Cash-flow-related Financial Difficulties\***  
 Per cent of households

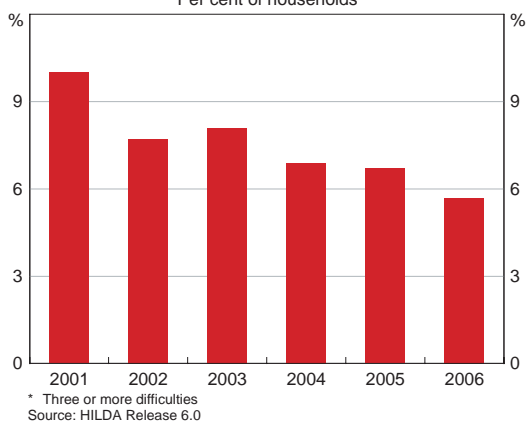

**Graph C3**  
**Other Indicators of Household Financial Position**  
 Per cent of households

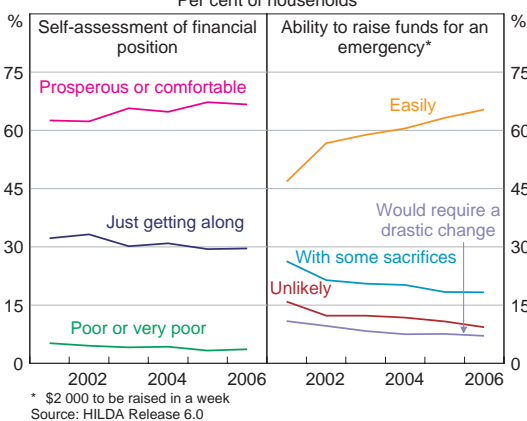

The HILDA Survey also asks households to make a self-assessment of their relative financial position given their current needs and financial responsibilities. Notwithstanding the more subjective nature of this indicator, the proportion of households that have a more positive perception of their financial position increased over the five years to 2006, with the share of households assessing themselves as *'just getting along'*, or *'poor or very poor'* declining (Graph C3). The survey also asks households about their ability to raise funds (\$2 000) in a week for an emergency. Again, the responses suggest that fewer households were in financial difficulty in 2006 than earlier in the decade. ✎



## Box D: Market Risk in the Household Asset Portfolio

The past two decades have seen a substantial expansion in household balance sheets. In 2007, the value of household assets was equivalent to over eight times annual household disposable income, compared with 4½ times income in 1990 (with assets net of debt – that is, net worth – also having grown strongly). Of these assets, around 40 per cent are financial assets, with the remainder largely accounted for by dwellings. Within financial asset holdings, there has been a marked shift towards assets that are market-linked, such as superannuation, equities and managed funds, and away from other financial assets, such as currency and deposits (Graph D1). The share of market-linked financial assets in total assets has risen from 17 per cent in 1990 to around 28 per cent in September 2007 (the latest available data).

The increase in holdings of market-linked financial assets reflects a number of factors, including: the introduction of compulsory employer superannuation contributions in the early 1990s; a higher proportion of household savings being invested directly in equities and managed funds; and, relatedly, significant valuation gains from strong asset markets. While valuation gains on households' total assets have been driven by significant capital returns on dwellings, capital returns on financial assets have also made a material contribution, particularly during the four years to September 2007 – a period of strong gains in the Australian share market (Graph D2).

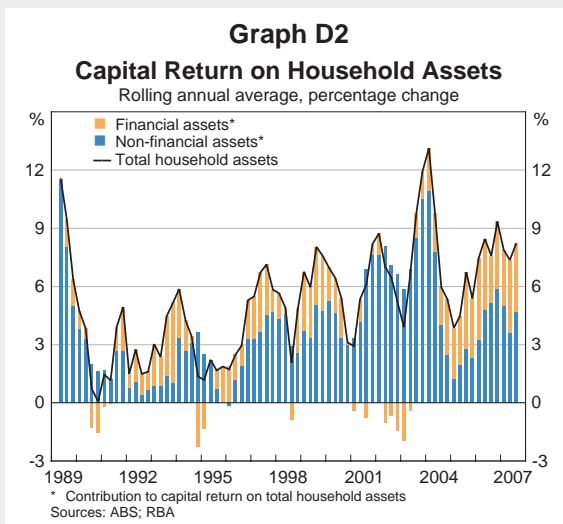
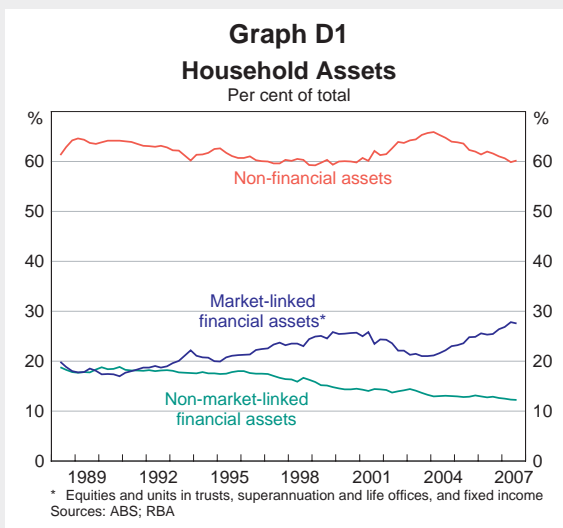

While the increased share of market-linked financial assets might be expected to boost long-run total capital returns, it can also make these returns more variable than in the past with, for example, households now being more exposed to the sort of volatility recently seen in equity markets. Consistent with this, although the volatility – as measured by standard deviations – of capital returns on individual financial asset classes was little changed between the periods 1988–1997 and 1998–2007, the volatility of capital returns on the overall portfolio of financial assets was higher, increasing from 1.9 per cent to 2.3 per cent (Table D1). While this could partly reflect changes in correlations between various capital returns, it appears to be fully explained by changes in asset composition; had there been no change in asset composition, then the volatility of capital returns on total financial assets would have been around the same as in the previous decade, at 1.8 per cent.

**Table D1: Volatility of Capital Returns on Household Assets**

Standard deviation of quarterly average capital returns, per cent<sup>(a)</sup>

Asset type	1988–1997	1998–2007	1998–2007 re-weighted <sup>(b)</sup>
<b>Financial</b>			
Market-linked financial	3.3	3.4	
<i>Of which:</i>			
Equities and units in trusts	7.2	7.2	
Superannuation and life offices	2.4	2.6	
Fixed income	3.0	2.0	
Non-market-linked financial <sup>(c)</sup>	0.7	0.6	
<b>Total financial</b>	<b>1.9</b>	<b>2.3</b>	<b>1.8</b>
<b>Non-financial</b>			
Dwellings	1.9	1.6	
Consumer durables	0.7	0.7	
<b>Total non-financial</b>	<b>1.7</b>	<b>1.4</b>	<b>1.4</b>
<b>Total assets</b>	<b>1.2</b>	<b>1.1</b>	<b>1.0</b>

(a) The actual periods covered are the September quarter 1988 to the December quarter 1997, and the March quarter 1998 to the September quarter 2007.

(b) Re-weighted with 1988–1997 period weights.

(c) Currency and deposits, unfunded superannuation, loans and ‘other’ financial assets.

Sources: ABS; RBA

Capital returns on the household sector’s aggregate asset portfolio have been less volatile than returns on both of its broad components in each of the past two decades, with the standard deviation of quarterly capital returns on the total portfolio being just over 1 per cent. Evidently, investing in these two distinct asset groups has provided households with some diversification benefits. ✎

# Developments in the Financial System Infrastructure

## Crisis Management Arrangements

Over recent years, the Council of Financial Regulators has been reviewing aspects of Australia's arrangements for the management of a financial crisis. Recently, as part of this work, the Council has examined possible lessons from the run on the UK bank Northern Rock, the first bank run in the United Kingdom for around 130 years.

One aspect of the UK arrangements that has featured prominently in the post-crisis evaluations is the design of the deposit insurance scheme. Prior to the run, depositors were guaranteed to receive repayment of the first £2 000 of any deposit in a failed bank, and 90 per cent of the next £33 000. There were, however, no arrangements in place to make these repayments to depositors in a timely fashion. The combination of the 10 per cent 'haircut' on repayments above £2 000 and likely delays in repayment are widely thought to have contributed to the scale of the run.

This experience is consistent with the Council's previous analysis that arrangements in Australia would be enhanced by the establishment of a scheme to repay depositors in a failed authorised deposit-taking institution (ADI) in a timely fashion. Under the existing legislation, depositors rank ahead of other creditors in a failed ADI, although they are likely to have to wait some time before they could be repaid. Given this, the Council is working on an Early Access Facility, which would provide early repayment of up to \$20 000 per depositor in a failed institution; it is estimated that this cap is sufficient to cover the entire deposits of around 80 per cent of depositors. Such a facility was recommended to the previous Government, and is before the current Government, while Council members have continued to investigate a number of technical issues relating to making early repayments to depositors in a closed institution.

A second element in dealing with a potential crisis is the provision of liquidity to the inter-bank market by the central bank. In this regard, arrangements in Australia are quite flexible. The Reserve Bank deals in the cash market every day, and adjusts the supply of settlement balances in line with changes in the demand for those balances. It is also prepared to deal with a wide range of counterparties and in a wide range of assets, and undertakes repurchase agreements with relatively long maturities on a regular basis. In addition, there is a safety valve through which institutions experiencing temporary technical settlement problems can obtain overnight funding at 25 basis points above the cash rate target. This additional flexibility has helped the system adjust to the recent periodic large increases in the demand for liquidity and the repricing of risks in inter-bank markets.

The UK experience has also focused attention on the difficulties that can arise when liquidity support outside of the central bank's normal operations becomes public knowledge. An important catalyst for the run on Northern Rock was rumours that the Bank of England was prepared to provide 'emergency' liquidity to the bank, with the run only being contained

when the Government announced a guarantee of deposits. Further, resolution of the difficulties at Northern Rock has been complicated by the difficulties that any new owner would have had in refinancing in the market the funding provided by the Bank of England. These difficulties contributed to the recent decision by the UK Government to take Northern Rock into public ownership.

The Council is currently examining the implications of this experience for crisis management arrangements in Australia. It is also reviewing APRA's powers for dealing with a distressed financial institution. While these powers are more extensive than those available to the Financial Services Authority in the United Kingdom, the Council has recommended legislative changes that would give a statutory manager appointed by APRA additional powers, and provide APRA with greater flexibility in arranging a takeover by, or a transfer of assets and liabilities to, another ADI in a timely fashion.

A final issue is the co-ordination arrangements among the authorities, which have been criticised in the United Kingdom. While the Council of Financial Regulators has no formal role in crisis management, all the relevant agencies are represented on the Council and would be in close contact during a crisis. Council members also recognise that in most situations it is the Government that is likely to play a leading role, particularly if taxpayers' funds are being put at risk. To date, communication arrangements have worked well, with Council members sharing liaison on a regular basis and discussing market developments frequently.

## **Basel II Capital Framework**

APRA's revised prudential standards for ADIs based on the Basel II Capital Framework came into effect on 1 January 2008. As discussed in previous *Reviews*, in calculating capital requirements under Pillar 1 of Basel II, an ADI must have regard to at least three business risks – credit risk, market risk and operational risk. The measurement of market risk – the risk of trading losses – is largely unchanged from the previous Capital Accord (Basel I). In contrast, the explicit measurement of operational risk – the risk of losses resulting from events such as fraud and technology failure – was absent from Basel I, while the measurement of credit risk – the risk of losses arising from default by customers or counterparties, and by far the largest risk for most ADIs – has been substantially reworked.

Basel II provides ADIs with three options for measuring credit risk. The 'standardised approach' is similar to Basel I, except that there is a wider range of risk weights, based on external credit rating agencies' assessment of differing borrower types. For ADIs with more sophisticated risk management systems, there are two 'internal ratings-based' (IRB) options. Under the Foundation IRB approach, ADIs use their own estimate of the probability of default for each borrower, but must apply the supervisor's estimate of the loss given default to determine the capital requirement. Under the Advanced IRB approach, ADIs can use their own estimates of both the probability of default and the loss given default to determine the capital requirement. There are also different approaches to managing operational risk.

The majority of Australian ADIs have adopted the Basel II standardised approaches for credit and operational risk and, in this regard, were not subject to an approval process. APRA's prior approval, however, was required before an ADI could adopt either of the IRB approaches for

credit risk or the advanced measurement approaches (AMA) for operational risk. To date, three banks have been approved to use the Advanced IRB approach, while one has been approved to use the Foundation IRB approach. In addition, three banks have applied to move to an IRB approach during 2008 but to remain under Basel I in the meantime. All four banks that are using the IRB approaches, as well as two other banks, have been approved to use the AMA approach for operational risk.

While the ADIs that were given approval to adopt the IRB and AMA approaches have met all the pre-requisites, APRA is continuing to discuss a number of risk estimates and categorisations with each of the ADIs concerned. Until these discussions are completed, it is difficult to determine the exact impact of changes to regulatory capital requirements; a clearer picture should be evident a little later this year with the introduction of a suite of new Basel II reporting forms. In any event, ADIs using the advanced approaches are subject to a cap of 10 per cent in 2008 on any reduction in capital requirements from the Basel II changes. (This cap will be retained during 2009 pending a review of the experience with the Basel II advanced approaches.) Any reductions in regulatory capital may also be offset by the end of transitional arrangements on 31 December 2007 for the introduction of International Financial Reporting Standards. Taking these various changes into account, and any further Pillar 2 adjustments which APRA is still to discuss with the ADIs concerned, changes to regulatory capital requirements for ADIs using the advanced approaches are likely to be modest.

## **APRA Review of ADIs' Liquidity Management Policies**

Recent events have greatly increased the attention that both financial institutions and regulators pay to liquidity management. The strains in financial markets over the past six months have seen some financial institutions provide significant funding under committed lines of credit, and simultaneously investors have required large premiums for committing funds for other than very short terms. These developments have led to some institutions running larger maturity mismatches than previously, and have focused attention on the management of those mismatches.

APRA's current prudential framework for liquidity risk requires each ADI to have a liquidity management strategy that is appropriate for the operations of that ADI, that is, a strategy that ensures that the ADI has sufficient liquidity to meet its obligations as they fall due. The strategy should set out how the ADI measures, manages and assesses its liquidity position and how it is able to respond to a liquidity crisis. As part of its liquidity management, an ADI would typically: set limits on maturity mismatches; set minimum benchmarks for holdings of high-quality liquid assets; and have strategies for a diversified liability base and for the sale of assets.

In addition, each of the larger ADIs must implement a liquidity scenario analysis framework to assess and measure its liquidity position under different operating circumstances. The two sets of scenarios specified in APRA's prudential standards, which an ADI is required to consider at a minimum, are a business-as-usual or 'going concern' scenario and a 'name crisis' scenario. The purpose of the first scenario is to assess the ADI's ability to meet its obligations under normal operating conditions. The second scenario is one in which the ADI confronts adverse circumstances specific to it and, as a consequence, has significant difficulty in rolling over or replacing its existing liabilities. For this scenario, the ADI must be able to demonstrate that it is capable of operating for at least five days in a crisis. In other words, the ADI's net cash

flow position over the five-day period must be positive, taking into account any expected cash receipts from realising liquid assets and other funding sources that would be available to the ADI in that situation.

In assessing their ability to meet a name crisis, the four largest banks are able to take into account the Interbank Deposit Agreement which can be drawn upon under adverse conditions. Under this agreement, if one of these banks is experiencing liquidity problems, the others can be required to deposit equal amounts of up to \$2 billion each for a month with that bank. At the end of the month, the recipient of the funds may choose to repay the deposits either in cash or by the assignment of mortgages. While this arrangement may be useful in dealing with a liquidity problem specific to just one bank, it is obviously of less use in a situation in which all banks are simultaneously experiencing liquidity difficulties.

In 2006, APRA began a comprehensive review of ADIs' liquidity risk management policies as well as its own supervisory regime in this area. The review has included an assessment of the current liquidity risk management practices of ADIs, in particular ADIs' approaches to liquidity scenario analysis and their participation in wholesale funding markets, including securitisation and offshore markets. APRA has also been reviewing the liquidity monitoring and supervision techniques of overseas regulators, and participates in a Basel Committee on Banking Supervision working group on liquidity that is reviewing existing international standards in this area. APRA plans to publish a discussion paper on liquidity management for industry consultation later in 2008, reflecting the work done in updating APRA's existing framework, issues highlighted by the recent global financial market turmoil, and the international policy direction.

In response to the recent turmoil in financial markets, APRA has significantly increased the intensity of its day-to-day monitoring of ADIs' liquidity and funding positions. Further, in late 2007, APRA requested that ADIs provide their most recent funding plans for calendar year 2008, updated to reflect current market conditions. APRA has recently been reviewing these plans and discussing them with institutions. This process will most likely be ongoing.

## Recent Changes to Insolvency Laws

There have recently been a number of changes to the insolvency laws arising from the *Corporations Amendment (Insolvency) Act 2007* that have strengthened the rights of creditors of a company placed in administration. One aspect of the insolvency laws is that they allow companies to use voluntary administration to act quickly, without the involvement of the courts, to resolve a business failure. The setting of tight time frames and milestones for completion of the various tasks in an administration is an important feature of this voluntary administration procedure. The recent changes increase creditors' opportunities to participate in statutory meetings, and allow administrators more time to conduct an examination of the company's financial circumstances and consider the best options for its future.<sup>3</sup> The changes also provide creditors with extra time to communicate with each other and determine whether they are

---

<sup>3</sup> *The time for holding the first creditors meeting has been extended from five to eight business days after the commencement of the administration. The administrator's notice of the first creditors' meeting has been extended from two to five business days prior to the meeting. The period for holding the second meeting of creditors has been extended to 25 business days with a new convening period of 20 business days. In addition, the time allowed for a creditor to enforce a charge, where it is a majority chargeholder, has been extended from 10 to 13 business days, thereby giving creditors more time to make an informed decision.*

satisfied with the company's/administrator's actions, and if not, creditors can resolve to replace the administrator appointed by the directors of the company with one of their choosing.

Other main changes include:

- ASIC and the Companies Auditors and Liquidators Disciplinary Board have been given greater powers to regulate insolvency practitioners and deal with misconduct;
- liquidators will have to report to ASIC annually, rather than once every three years. ASIC will also have the power to review an administrator's remuneration; and
- administrators will be required to declare any 'relevant relationships' and declare any indemnities that have been provided.

In a related development, the Insolvency Practitioners Association of Australia, in consultation with ASIC and the Insolvency and Trustee Service Australia, has issued a new *Code of Professional Practice for Insolvency Professionals*. The code has been effective since 31 December 2007 and is intended to support compliance with the new law.

## Issuance of Debentures to Retail Investors

Following the collapse of several property development companies in recent years, ASIC has taken a number of steps to improve disclosure requirements applying to unlisted and unrated debentures. This follows concerns that retail investors in these debentures did not always fully understand the risks that they were taking. In mid 2007, it is estimated that unlisted and unrated debentures accounted for approximately \$8 billion of the \$34 billion in debentures held by retail investors and self-managed superannuation funds.

ASIC's proposed changes were released for industry consultation in August 2007. This was followed in October 2007 by the release of the new requirements in *Regulatory Guide 69 – Debentures – Improving Disclosure for Retail Investors*. Under the new arrangements, disclosure benchmarks have been set for, among other things, equity capital, liquidity, related-party transactions and credit ratings. If issuers do not meet these benchmarks, they are required to explain why this is so. ASIC is now reviewing fundraising documents against this 'if not, why not' approach, with a view to issuing a public report in June 2008.

Another element of ASIC's response relates to the advertising of debentures. In December 2007, ASIC released *Regulatory Guide 156 – Debentures Advertising* which details several principles-based standards in relation to the advertising of debentures. The standards, which apply only if the debentures are offered to retail investors, require that advertisements:

- include a prominent statement to the effect that investors risk losing some or all of their principal investment;
- only quote an interest rate if it is accompanied by prominent disclosure of either the current credit rating for the debenture and what that means, or where to find this information, or, where the debenture does not have a rating, explain the implications of the debenture not having a rating;
- state that the debenture is not a bank deposit and avoid the use of terms such as 'secure', 'secured', and 'guaranteed', as these statements may convey a misleading impression as to the risk profile of the debenture;

- not state, or imply, that the investment is suitable for a particular class of investor; and
- be consistent with the corresponding disclosures in the prospectus.

In addition, any statements made in response to inquiries are subject to the same regulation regarding misleading and deceptive conduct as the advertisements.

The guide also makes clear that ASIC expects publishers to have systems and controls to detect and refuse advertisements for debentures that do not comply with these advertising standards. While the primary responsibility for advertising material rests with the organisation placing the advertisement, the publisher or other media conduit may also have some responsibility for its content. Accordingly, ASIC has included guidance on the role of publishers and the media in promoting debenture products.

Compliance with the new standards for advertising has been in effect since February 2008.

## Regulation of Mortgage Brokers

As discussed in previous *Reviews*, the regulation of mortgage brokers in Australia has been under consideration for some time. In part, this reflects concerns that a small number of brokers may have been associated with predatory lending practices and that their remuneration structures – predominantly high upfront and low trailing commissions – might have adverse consequences for both borrowers and lenders. Another concern is that there is no national licensing or regulation of mortgage brokers.

In November 2007, the NSW Office of Fair Trading released a draft Bill intended to form the basis for all states and territories to regulate their finance and broking industries. The draft Bill was prepared for the Ministerial Council on Consumer Affairs by the Finance Broking Working Group (chaired by NSW and comprising the Commonwealth Treasury, ASIC and all state and territory governments) and takes account of input from regulators, the broking industry and consumer representatives.

Under the proposed arrangements, all broking services would be regulated, with the only exceptions being a broking service provided to a business with more than 20 employees (100 employees if a manufacturer), or to a business seeking credit in excess of \$2 million.

In addition, strict licensing requirements would be established to ensure only reputable brokers join the industry, with, for example, licensees being required to meet certain qualification and ongoing training requirements. Licensees would also need to be members of an ASIC-approved external dispute resolution scheme, with decisions binding on the broker. Probity and police checks would also be undertaken to prevent applicants with a history of unfair practices from obtaining a licence.

Other features of the draft Bill include:

- a requirement that the broker provide specified disclosures about costs and services before negotiating a broking agreement with the client;
- a requirement that brokers make sufficient enquiries about the consumer's financial status to ensure that they can afford the product recommended;
- the establishment of a national register of authorised brokers;



- a requirement that brokers have professional indemnity insurance so that any claim on a broker can be met;
- provision for a stay of home repossession where damages are being claimed from the broker that could allow the consumer to get their repayments back on track;
- a prohibition on charging upfront fees until the credit has been formally offered and on lodging caveats over property to secure fees; and
- a requirement that brokers recommending a reverse mortgage provide analysis that shows why this is the right product for the consumer's circumstances and a requirement that the broker give examples to the consumer to illustrate the reduction in their equity in the home over a period of time.

Submissions on the draft Bill closed on 15 February 2008.

## Competing Market Venues for the Trading of ASX-listed Securities

Under the *Corporations Act 2001*, an operator of a 'financial market', such as a trading platform for equities, must have an Australian Market Licence that is granted by an Australian Government minister; at present this responsibility sits with the Minister for Superannuation and Corporate Law. A prospective provider must submit an application through ASIC, which then provides this application to the Minister along with advice as to whether the operator will be able to comply with obligations set out in the Act and related Corporations Regulations. Once a licence is granted, the chief obligation on the licensee is that it ensures its market is fair, orderly and transparent. ASIC undertakes regular assessments to monitor the licensee's compliance with this obligation.

In 2007, ASIC received formal market licence applications from AXE ECN Pty Ltd and Liquidnet Australia Pty Ltd. Both of these applicants propose to provide services for the trading of equities listed on the Australian Securities Exchange (ASX), thereby competing with the trading services offered by the ASX.

While competition of this nature has existed for some time in other countries, this is the first time the Australian regulatory authorities have received such applications. While such competition is to be welcomed, the prospect of the same listed securities being traded simultaneously in multiple trading venues raises important issues around the transparency, integrity, supervisory ability and efficiency of both individual market operators and the market for ASX-listed securities as a whole.

Because of these broader considerations, ASIC has undertaken a lengthy period of consultation. It released a consultation paper in July 2007, *Competition for market services – trading in listed securities and related data*, and, after considering submissions to this paper, released a second paper in November 2007, with the response period having closed on 29 January 2008. ASIC has recently provided its advice to the Minister on these matters.

So as to provide transparency to the process by which prospective market operators might access its clearing and settlement facilities, the ASX launched a public consultation in March 2008, setting out a timetable for the release and implementation of an access regime for these facilities. ✕